

MultiWood

MultiWood Inc.

Product Catalogue

RETAIL

11580 40th Street SE

Calgary AB, T2Z 4V6

info@multiwood.com

multiwood.com

P 403-279-7789

F 403-279-2816

Hours of Operation

Mon—Thurs 7:30 to 5:00

Friday 7:30 to 4:00

The Multiwood Advantage

Mission Statement

To Provide High Quality Products at Competitive Prices with On-Time Deliveries, While
Striving to Provide a Safe and Friendly Work Environment.

Contents	Page #
Butcher Blocks	24
Cabinet Componets	33
Doors (Custom Wood & MDF)	20
Doors (MDF)	17-19
Doors (Mitered Wood)	14-16
Doors (Passage)	25-26
Doors (Ply & Melamine)	22
Doors (Standard)	5-13
Dovertail Drawer Boxes	37
Drilling styles	23
Edge profiles	21
Edge Tape	32
Hand Rail & Bracket	23
Hardware	34-35
Mouldings	27-30
Misc Items	24
Nexgen Products	38
Pricing (MDF)	19
Pricing (Wood)	3,13
Return Air Grills	24
Sheet Goods	31
Shelf Brackets / Corbels	24
Soild Lumber	30
Table Tops	24
Warranty	36
Wine Racks	23
Wood Specs	4

Products

Cabinet Doors - We produce a wide range of solid wood cabinet doors (standard and mitered, MDF routed doors and slab-plywood doors). Applied mouldings are available for many of our doors as well.

Passage Doors - We produce high end interior solid wood and MDF passage doors to your specifications.

Mouldings - We produce hard wood mouldings in all domestic wood types and some exotic species. We stock hard wood mouldings in maple, poplar, and other species. We make custom MDF mouldings to your specifications.

Kitchen Components - **We produce and stock 5/8" melamine kitchen** components in white and classic maple melamine. Our system is designed to be as flexible as possible for the contractor who can design and install custom kitchens.

Hardware - We stock cabinet door European hinges, drawer slides (accuride and hettich), and a variety of items for basic assembly.

Custom Machining - We specialize in high production, including CNC routing and drilling, sheet goods cut to size, planing solid lumber, straight line ripping, laminating, sanding and custom mouldings. We also welcome custom design orders or other wood types. We feature fast turn-around times. Please inquire.

Pricing

We have provided pricing for selected sizes and styles of oak doors for reference purposes only. Customers are encouraged to contact our order desk for a written quote. Catalogue prices are subject to change without notice. Quoted prices will be honored for 30 days. Wood Factors (upcharge by wood type)

Species	Mark up
African Mahogany**	100%
Alder (Clear or Knotty)	20%
Beech	40%
Cherry	54%
Hickory	20%
Knotty Pine	20%
Maple (Brown)	28%
Maple (Brown) MDF Panel	22%
Maple(White Hard)	35%
Oak	Base Price
QTR Sawn Red Oak**	Quote
QTR Sawn White Oak**	230%
Rift Cut (Vertical Grain) Fir	40%
Rift Cut Red Oak**	70%
Rift Cut White Oak**	170%
Walnut	160%
White Oak	76%

** Not available in plywood panel doors
(ie: MW1, MW2, MN1, MS1, etc.)

Payment Terms

We accept cash, debit card, VISA, MasterCard or Company Cheque (must be personalized with company name, address and phone number). Cheques that are returned NSF will be subject to a service charge of \$45.00. Advance full payment is required with all non-account customers.

Order Changes & Cancellations

There will be a minimum \$35.00 revision/cancellation charge, or the following charges will be applied: 33% of item price after the first day, 66% of item price after the second day, 100% item price after the third day.

Pick-up & Delivery Service

All orders must be picked up or have delivery scheduled within 90 days after completion. Any order beyond this 90 day period may become property of Multiwood Inc . We offer delivery within the city of Calgary and to outlying communities including Okotoks, Cochrane, Airdrie and Chestermere Lake.

Wood Specifications

Multiwood is proud to produce fine products from a wide variety of wood species. Red oak, maple, pine, cherry, alder, walnut and hickory are some of the many species we work with. The characteristics of each species are unique, and equally as unique is each tree. Due to genetic differences, soil, moisture and weather, the wood we get in any one species varies widely. These natural variations - "God's Fingerprints" - give wood the beauty that we have learned to appreciate. It is impossible to guarantee that all pieces used will have uniform colour, and be free of these natural marks. Knotty wood is available in most species. Please Inquire!

Alder - Alder is separated into clear and knotty alder

Clear Alder Sound pin knots up to **1/8"** may appear on the face of the door, and up to **3/16"** on the back. Colour Streaks up to **1/4" by 2"** are acceptable on the face of the door, and the back.

Knotty Alder Sound knots of any size are acceptable, and see through holes in knots are allowed, if they are small. Color Streaks are acceptable, if there are no cracks or splits in the streak and it is sound. No pitch pockets are acceptable.

Note: Some panels may have limited or no knots due to the nature of the wood. Whether a door is "too knotty" or "not knotty enough" is subjective, and cannot be warranted for replacement.

Cherry - American Black Cherry is used for all of our cherry products. (the wood is named for the colour of the berry). The heartwood is colour matched and a reasonable grain match is made. The natural characteristics of cherry include mineral streaks, gum pockets, figured grain and pin knots. **Pin knots up to 1/8"** may be found on the face for the doors and up to **3/16"** on the back. **Mineral streaks and gum pockets may be found up to 1/8" by 2 1/2" long on the face of the door, gum pockets of any size and quantity may be found on the back of the door, as long as there are no cracks or splits in the streak.** Sap can be included in the face on request, and may be present on the back as long as it is sound.

Hickory - Northern True Hickory is used for all our hickory products. Heartwood and sapwood is always mixed in various degrees. This results in extreme colour and grain variation which give it a rustic look. Sound pin knots up to **1/8"** may appear on the face of the door, and up to **3/16"** on the back.

Knotty Pine - Eastern White Pine, or Furniture Pine, is used for our pine products. It is the preferred pine; due to its low pitch content. The doors will have knots in the panels but may, or may not have knots in the stiles and rails. Knots may extend to an edge of the stile and rail, but not the entire piece, and can be as large as **3"** in diameter. Cracks in knots that penetrate the thickness of the door are allowed. Pitch and mineral streaks up to **1/2" wide by 6" long** may be found on the face of the door. **Note: Some panels may have limited or no knots due to the nature of the wood. Whether a door is "too knotty" or "NOT knotty enough" is subjective, and cannot be warranted for replacement.**

Maple - Sugar Maple, also known as White Hard Maple is used for all our maple products. We separate our maple products into two categories: Maple, and Brown Maple. This is based on a combination of colour and natural defects.

Maple will be all white wood face. Mineral streaks **1/8" by 3/4" long** may occur on the face of the door and **1/4" by 3"** on the back. Some Brown or sugar tracks (heartwood) may occur on the back of the door. Sound pin knots up to **1/8"** may appear on the face of the door, and up to **3/16"** on the back. Some color streaks of **1/8" by 2/4"** are acceptable on the face, and some brown or light green color streaks are acceptable on the back.

Brown Maple - will include heartwood and any natural defects, and miscellaneous sound defects, in any quantity and size. Brown and dark streaks may occur on face and back in any size and shape.

Red Oak - Northern red oak is used for all our oak products. It is the most colour consistent of all red oak. We will make a reasonable colour and grain match. Colour variations are considered normal. Excessive mineral streaks are not allowed. Mineral streaks up to **1/8" by 2"** may be found on the face of the doors and on the backs. Sound pin knots up to **1/8"** may appear on the face of the door, and up to **3/16"** on the back. Sapwood up to **1"** is acceptable on the back of the door, as long as it does not show through the face.

Walnut - Sound pin knots up to **1/8"** may appear on the face of the door, and up to **3/16"** on the back. Sapwood up to a width of **1"** is acceptable on the back of the door, as long as it does not show through the face.

Our doors are sold unfinished and should not be left any length of time before finishing. Color changes will occur when wood is exposed to light and air. Finishing will slow down the process but changes in color will still occur. Unfinished wood can change color rapidly especially in the case of cherry. It is recommended that cherry be kept covered until you are ready to finish. Care should be taken when storing doors prior to finishing, or installation. Avoid Extreme Cold, Heat and Humidity

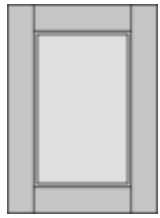

Square

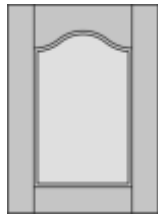

Cathedral

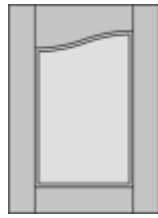

Left Cathedral

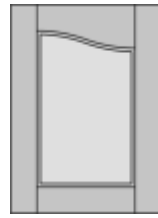

Right Cathedral

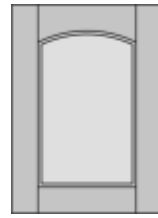

Eyebrow

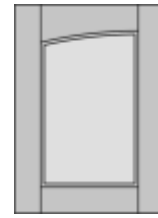

Left Eyebrow

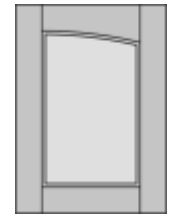

Right Eyebrow

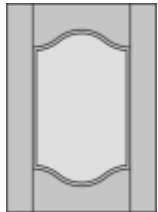

Double Cathedral

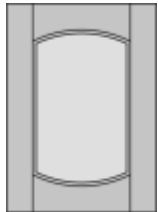

Double Eyebrow

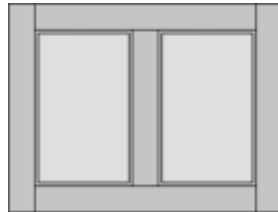

Square Side x Side
Recommended 28" and wider

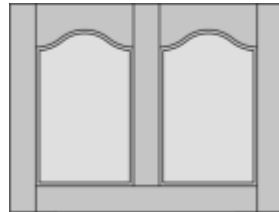

Cathedral Side x Side
Recommended 28" and wider

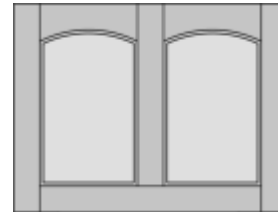

Eyebrow Side x Side
Recommended 28" and wider

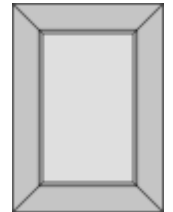

All Mitered Doors

Double panel and triple panel doors are recommended to prevent warpage on larger doors. Doors 42" or higher should have a double panel, doors 62" or higher should have a triple panel. Doors over 26" wide should have side by side double panels.

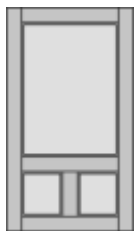

1A2 (1 Panel above 2)

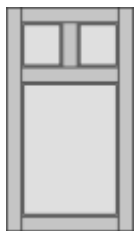

2A1 (2 Panels above 1)



Double Panel with Cathedral top

Recommended over 42" high



Triple Panel with Eyebrow F4 Frame

Recommended over 62" high



Quadruple Panel

Recommended over 80" high

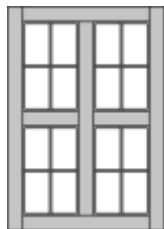

Double Panel Side x Side with F4 Frames

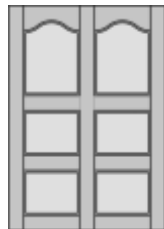

Triple Panel Side x Side with Cathedral Top



Wainscoting (G1S) - Advise the number of panels required. Individual panels should be no wider than 24 inches. Overall width should be maximum 108 inches, anything over this requires a special quote

Please note - These are only examples, as there are many combinations of Double, Triple, Quadruple Panel and Side by Side Doors available by selecting different shape and frame options. Also, the location of middle rails can vary according to your preference. Not available in the Miter Door style. **No warranty for doors over 50" high or 28" wide.

French Frames

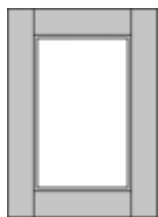

F

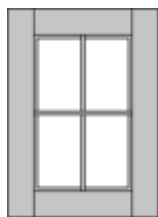

F4

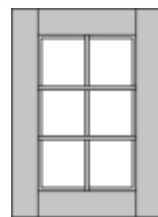

F6

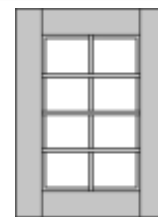

F8

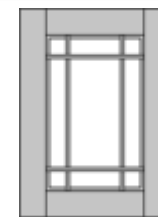

F9

Standard: Frames available in all shapes including Cathedral and Eyebrow

MDF: Frames available in all shapes including Cathedral and Eyebrow

Miter: Open frame for all. Mullions in MN, MT, MX and MR only.

All frames are optionally available with groove and vinyl insert for easy installation of 3mm thick glass (see page 15). This option is available free of charge in either white or brown. When ordering frame doors please include door style and frame number: ie: **MW3 F8**

Shaker Stile/Rail with Optional Panels for Doors

See Page 21 for Outside Edge Profile Options

 <p>Shaker Stile/Rail</p>	Codes with Suffix "F" See Page 3 for Frame Options	CODES	MINIMUM SIZES	Height		Width	
		MS1 F	Square, Full Drawer	130mm	5 1/8	140mm	5 1/2
		MS2 F	Cathedral & Half	171mm	6 3/4	189mm	7 7/16
		MS8 F	Eyebrow & Half	156mm	6 1/8	189mm	7 7/16
		DS1 F	Reduced Rail Drawer	92mm	3 5/8	140mm	5 1/2

 <p>Shaker Stile/Rail Ply Panel</p>	CODES	MINIMUM SIZES	Height		Width	
	MS1, MS1 HG	Square, Full Drawer	130mm	5 1/8	140mm	5 1/2
	MS2, MS5L, MS5R	Cathedral & Half	171mm	6 3/4	189mm	7 7/16
	MS8, MS7L, MS7R	Eyebrow & Half	156mm	6 1/8	189mm	7 7/16
	DS1	Reduced Rail Drawer	92mm	3 5/8	140mm	5 1/2

 <p>Shaker Stile/Rail Cove Panel</p>	CODES	MINIMUM SIZES	Height		Width	
	MSC3, MSC3 HG	Square, Full Drawer	173mm	6 13/16	173mm	6 13/16
	MSC4, MSC6L, MSC6R	Cathedral & Half	214mm	8 7/16	189mm	7 7/16
	MSC9, MSC10L, MSC10R	Eyebrow & Half	198mm	7 13/16	189mm	7 7/16
	DSC	Reduced Rail Drawer	135mm	5 5/16	173mm	6 13/16

 <p>Shaker Stile/Rail Multiwood Panel</p>	CODES	MINIMUM SIZES	Height		Width	
	MS3, MS3 HG	Square, Full Drawer	168mm	6 5/8	168mm	6 5/8
	MS4, MS6L, MS6R	Cathedral & Half	210mm	8 1/4	189mm	7 7/16
	MS9, MS10L, MS10R	Eyebrow & Half	194mm	7 5/8	189mm	7 7/16
	DS3	Reduced Rail Drawer	130mm	5 1/8	168mm	6 5/8

 <p>Shaker Stile/Rail Pearl Panel</p>	CODES	MINIMUM SIZES	Height		Width	
	MSP3, MSP3 HG	Square, Full Drawer	184mm	7 1/4	184mm	7 1/4
	MSP4, MSP6L, MSP6R	Cathedral & Half	225mm	8 7/8	189mm	7 7/16
	MSP9, MSP10L, MSP10R	Eyebrow & Half	210mm	8 1/4	189mm	7 7/16
	DSP	Reduced Rail Drawer	146mm	5 3/4	184mm	7 1/4

 <p>Shaker Stile/Rail Bevel Panel</p>	CODES	MINIMUM SIZES	Height		Width	
	MSB, MSB HG	Square, Full Drawer	184mm	7 1/4	184mm	7 1/4
	Not Available	Cathedral & Half	-	-	-	-
	Not Available	Eyebrow & Half	-	-	-	-
	DSB	Reduced Rail Drawer	146mm	5 3/4	184mm	7 1/4

 <p>Shaker Stile/Rail Soft Panel</p>	CODES	MINIMUM SIZES	Height		Width	
	MSS, MSS HG	Square, Full Drawer	184mm	7 1/4	184mm	7 1/4
	MSS4, MSS6L, MSS6R	Cathedral & Half	225mm	8 7/8	189mm	7 7/16
	MSS9, MSS10L, MSS10R	Eyebrow & Half	210mm	8 1/4	189mm	7 7/16
	DSS	Reduced Rail Drawer	146mm	5 3/4	184mm	7 1/4

 <p>Shaker Stile/Rail Reversed Panel</p>	BP and VP	CODES	MINIMUM SIZES	Height		Width	
	Suffix "BP" or "VP" to Codes Directly to Right	MSR, MSR HG	Square, Full Drawer	130mm	5 1/8	140mm	5 1/2
		MSR4, MSR6L, MSR6R	Cathedral & Half	171mm	6 3/4	189mm	7 7/16
		MSR9, MSR10L, MSR10R	Eyebrow & Half	156mm	6 1/8	189mm	7 7/16
	DSR VGBP, DSR VGVP	DSR	Reduced Rail Drawer	92mm	3 5/8	140mm	5 1/2

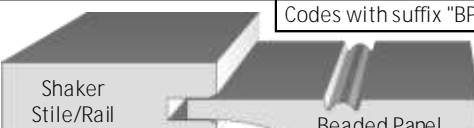
 <p>Shaker Stile/Rail Beaded Panel</p>	Codes with suffix "BP"

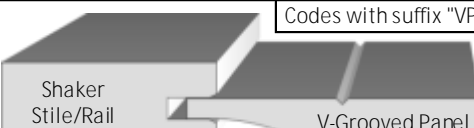
 <p>Shaker Stile/Rail V-Grooved Panel</p>	Codes with suffix "VP"

Drawer Front Options

Slab

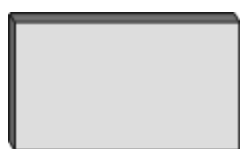

DFB - Drawer Front Blank

Reduced Rail



2 1/4" Stile with 1 1/2" Rail
(codes starting with "D")

Full Sized Rail





2 1/4" Stile and Rail (all codes with suffix "HG")

Cove Stile/Rail with Optional Panels for Doors

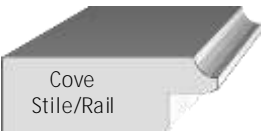
See Page 21 for Outside Edge Profile Options

 <p>Cove Stile/Rail</p>	Codes with Suffix "F" See Page 3 for Frame Options	CODES	MINIMUM SIZES	Height		Width	
		MW1 F	Square, Full Drawer	130mm	5 1/8	140mm	5 1/2
		MW2 F	Cathedral & Half	171mm	6 3/4	189mm	7 7/16
		MW8 F	Eyebrow & Half	156mm	6 1/8	189mm	7 7/16
		DF1 F	Reduced Rail Drawer	92mm	3 5/8	140mm	5 1/2

 <p>Cove Stile/Rail Ply Panel</p>	CODES	MINIMUM SIZES	Height		Width	
	MW1, MW1 HG	Square, Full Drawer	130mm	5 1/8	140mm	5 1/2
	MW2, MW5R, MW5L	Cathedral & Half	171mm	6 3/4	189mm	7 7/16
	MW8, MW7L, MW7R	Eyebrow & Half	156mm	6 1/8	189mm	7 7/16
	DF1	Reduced Rail Drawer	92mm	3 5/8	140mm	5 1/2

 <p>Cove Stile/Rail Cove Panel</p>	CODES	MINIMUM SIZES	Height		Width	
	MC3, MC3 HG	Square, Full Drawer	173mm	6 13/16	173mm	6 13/16
	MC4, MC6L, MC6R	Cathedral & Half	214mm	8 7/16	189mm	7 7/16
	MC9, MC10L, MC10R	Eyebrow & Half	198mm	7 13/16	189mm	7 7/16
	DC3	Reduced Rail Drawer	135mm	5 5/16	173mm	6 13/16

 <p>Cove Stile/Rail Multiwood Panel</p>	CODES	MINIMUM SIZES	Height		Width	
	MW3, MW3 HG	Square, Full Drawer	168mm	6 5/8	168mm	6 5/8
	MW4, MW6L, MW6R	Cathedral & Half	210mm	8 1/4	189mm	7 7/16
	MW9, MW10L, MW10R	Eyebrow & Half	194mm	7 5/8	189mm	7 7/16
	DF3	Reduced Rail Drawer	130mm	5 1/8	168mm	6 5/8

 <p>Cove Stile/Rail Pearl Panel</p>	CODES	MINIMUM SIZES	Height		Width	
	MP3, MP3 HG	Square, Full Drawer	184mm	7 1/4	184mm	7 1/4
	MP4, MP6L, MP6R	Cathedral & Half	225mm	8 7/8	189mm	7 7/16
	MP9, MP10L, MP10R	Eyebrow & Half	210mm	8 1/4	189mm	7 7/16
	DP3	Reduced Rail Drawer	146mm	5 3/4	184mm	7 1/4

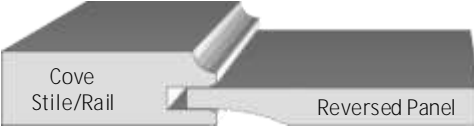

 <p>Cove Stile/Rail Bevel Panel</p>	CODES	MINIMUM SIZES	Height		Width	
	MB3, MB3 HG	Square, Full Drawer	184mm	7 1/4	184mm	7 1/4
	Not Available	Cathedral & Half	-	-	-	-
	Not Available	Eyebrow & Half	-	-	-	-
	DB3	Reduced Rail Drawer	146mm	5 3/4	184mm	7 1/4

 <p>Cove Stile/Rail Soft Panel</p>	CODES	MINIMUM SIZES	Height		Width	
	MWS, MWS HG	Square, Full Drawer	184mm	7 1/4	184mm	7 1/4
	MWS4, MWS6L, MWS6R	Cathedral & Half	225mm	8 7/8	189mm	7 7/16
	MWS9, MWS10L, MWS10R	Eyebrow & Half	210mm	8 1/4	189mm	7 7/16
	DFS	Reduced Rail Drawer	146mm	5 3/4	184mm	7 1/4

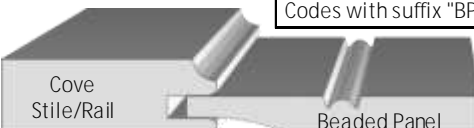
 <p>Cove Stile/Rail Reversed Panel</p>	BP and VP	CODES	MINIMUM SIZES	Height		Width	
	Suffix "BP" or "VP" to Codes Directly to Right	MWR, MWR HG	Square, Full Drawer	130mm	5 1/8	140mm	5 1/2
		MWR4, MWR6L, MWR6R	Cathedral & Half	171mm	6 3/4	189mm	7 7/16
		MWR9, MWR10L, MWR10R	Eyebrow & Half	156mm	6 1/8	189mm	7 7/16
	DFR VG, DFR VGVP	DFR	Reduced Rail Drawer	92mm	3 5/8	140mm	5 1/2

 <p>Cove Stile/Rail Beaded Panel</p>	Codes with suffix "BP"

 <p>Cove Stile/Rail V-Grooved Panel</p>	Codes with suffix "VP"

Drawer Front Options		
Slab	Reduced Rail	Full Sized Rail
		
DFB - Drawer Front Blank	2 1/4" Stile with 1 1/2" Rail (codes starting with "D")	2 1/4" Stile and Rail (all codes with suffix "HG")

Ogee Stile/Rail with Optional Panels for Doors

See Page 21 for Outside Edge Profile Options

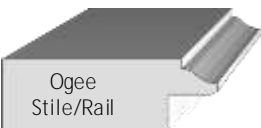
 <p>Ogee Stile/Rail</p>	Codes with Suffix "F" See Page 3 for Frame Options	CODES	MINIMUM SIZES	Height		Width	
		OW1 F	Square, Full Drawer	130mm	5 1/8	140mm	5 1/2
		OW2 F	Cathedral & Half	171mm	6 3/4	200mm	7 7/8
		OW8 F	Eyebrow & Half	156mm	6 1/8	200mm	7 7/8
		EF1 F	Reduced Rail Drawer	92mm	3 5/8	140mm	5 1/2

 <p>Ogee Stile/Rail Ply Panel</p>	CODES	MINIMUM SIZES	Height		Width	
	OW1, OW1 HG	Square, Full Drawer	130mm	5 1/8	140mm	5 1/2
	OW2, OW5L, OW5R	Cathedral & Half	171mm	6 3/4	200mm	7 7/8
	OW8, OW7L, OW7R	Eyebrow & Half	156mm	6 1/8	200mm	7 7/8
	EF1	Reduced Rail Drawer	92mm	3 5/8	140mm	5 1/2

 <p>Ogee Stile/Rail Cove Panel</p>	CODES	MINIMUM SIZES	Height		Width	
	OC3, OC3 HG	Square, Full Drawer	173mm	6 13/16	173mm	6 13/16
	OC4, OC6L, OC6R	Cathedral & Half	214mm	8 7/16	200mm	7 7/8
	OC9, OC10L, OC10R	Eyebrow & Half	198mm	7 13/16	200mm	7 7/8
	EC3	Reduced Rail Drawer	135mm	5 5/16	173mm	6 13/16

 <p>Ogee Stile/Rail Multiwood Panel</p>	CODES	MINIMUM SIZES	Height		Width	
	OW3, OW3 HG	Square, Full Drawer	168mm	6 5/8	168mm	6 5/8
	OW4, OW6L, OW6R	Cathedral & Half	210mm	8 1/4	200mm	7 7/8
	OW9, OW10L, OW10R	Eyebrow & Half	194mm	7 5/8	200mm	7 7/8
	EF3	Reduced Rail Drawer	130mm	5 1/8	168mm	6 5/8

 <p>Ogee Stile/Rail Pearl Panel</p>	CODES	MINIMUM SIZES	Height		Width	
	OP3, OP3 HG	Square, Full Drawer	184mm	7 1/4	184mm	7 1/4
	OP4, OP6L, OP6R	Cathedral & Half	225mm	8 7/8	200mm	7 7/8
	OP9, OP10L, OP10R	Eyebrow & Half	210mm	8 1/4	200mm	7 7/8
	EP3	Reduced Rail Drawer	146mm	5 3/4	184mm	7 1/4



 <p>Ogee Stile/Rail Bevel Panel</p>	CODES	MINIMUM SIZES	Height		Width	
	OB3, OB3 HG	Square, Full Drawer	184mm	7 1/4	184mm	7 1/4
	Not Available	Cathedral & Half	-	-	-	-
	Not Available	Eyebrow & Half	-	-	-	-
	EB3	Reduced Rail Drawer	146mm	5 3/4	184mm	7 1/4

 <p>Ogee Stile/Rail Soft Panel</p>	CODES	MINIMUM SIZES	Height		Width	
	OWS, OWS HG	Square, Full Drawer	184mm	7 1/4	184mm	7 1/4
	OS4, OS6L, OS6R	Cathedral & Half	225mm	8 7/8	200mm	7 7/8
	OS9, OS10L, OS10R	Eyebrow & Half	210mm	8 1/4	200mm	7 7/8
	EFS	Reduced Rail Drawer	146mm	5 3/4	184mm	7 1/4

 <p>Ogee Stile/Rail Reversed Panel</p>	BP and VP	CODES	MINIMUM SIZES	Height		Width	
	Suffix "BP" or "VP" to Codes Directly to Right EFR VGBP, EFR VGVP	OWR, OWR HG	Square, Full Drawer	130mm	5 1/8	140mm	5 1/2
		OR4, OR6L, OR6R	Cathedral & Half	171mm	6 3/4	200mm	7 7/8
		OR9, OR10L, OR10R	Eyebrow & Half	156mm	6 1/8	200mm	7 7/8
		EFR	Reduced Rail Drawer	92mm	3 5/8	140mm	5 1/2

 <p>Ogee Stile/Rail Beaded Panel</p>	Codes with suffix "BP"

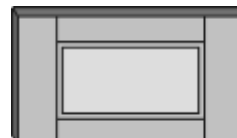
 <p>Ogee Stile/Rail V-Grooved Panel</p>	Codes with suffix "VP"

Drawer Front Options		
Slab	Reduced Rail	Full Sized Rail
		
DFB - Drawer Front Blank	2 1/4" Stile with 1 1/2" Rail (codes starting with "D")	2 1/4" Stile and Rail (all codes with suffix "HG")

V-Groove Through Stile/Rail with Optional Panels for Doors

See Page 21 for Outside Edge Profile Options

 <p>V-Groove Stile/Rail</p>	Codes with Suffix "F" See Page 3 for Frame Options	CODES	MINIMUM SIZES	Height		Width	
		VS1 F	Square, Full Drawer	130mm	5 1/8	140mm	5 1/2
		VS2 F	Cathedral & Half	171mm	6 3/4	189mm	7 7/16
		VS8 F	Eyebrow & Half	156mm	6 1/8	189mm	7 7/16
		VF1 F	Reduced Rail Drawer	92mm	3 5/8	140mm	5 1/2

 <p>V-Groove Stile/Rail Ply Panel</p>	CODES	MINIMUM SIZES	Height		Width	
	VS1, VS1 HG	Square, Full Drawer	130mm	5 1/8	140mm	5 1/2
	VS2, VS5L, VS5R	Cathedral & Half	171mm	6 3/4	189mm	7 7/16
	VS8, VS7L, VS7R	Eyebrow & Half	156mm	6 1/8	189mm	7 7/16
	VF1	Reduced Rail Drawer	92mm	3 5/8	140mm	5 1/2

 <p>V-Groove Stile/Rail Cove Panel</p>	CODES	MINIMUM SIZES	Height		Width	
	VSC, VSC HG	Square, Full Drawer	173mm	6 13/16	173mm	6 13/16
	VSC4, VSC6L, VSC6R	Cathedral & Half	214mm	8 7/16	189mm	7 7/16
	VSC9, VSC10L, VSC10R	Eyebrow & Half	198mm	7 13/16	189mm	7 7/16
	VFC	Reduced Rail Drawer	135mm	5 5/16	173mm	6 13/16

 <p>V-Groove Stile/Rail Multiwood Panel</p>	CODES	MINIMUM SIZES	Height		Width	
	VS3, VS3 HG	Square, Full Drawer	168mm	6 5/8	168mm	6 5/8
	VS4, VS6L, VS6R	Cathedral & Half	210mm	8 1/4	189mm	7 7/16
	VS9, VS10L, VS10R	Eyebrow & Half	194mm	7 5/8	189mm	7 7/16
	VF3	Reduced Rail Drawer	130mm	5 1/8	168mm	6 5/8

 <p>V-Groove Stile/Rail Pearl Panel</p>	CODES	MINIMUM SIZES	Height		Width	
	VSP, VSP HG	Square, Full Drawer	184mm	7 1/4	184mm	7 1/4
	VSP4, VSP6L, VSP6R	Cathedral & Half	225mm	8 7/8	189mm	7 7/16
	VSP9, VSP10L, VSP10R	Eyebrow & Half	210mm	8 1/4	189mm	7 7/16
	VFP	Reduced Rail Drawer	146mm	5 3/4	184mm	7 1/4

 <p>V-Groove Stile/Rail Bevel Panel</p>	CODES	MINIMUM SIZES	Height		Width	
	VS8, VS8 HG	Square, Full Drawer	184mm	7 1/4	184mm	7 1/4
	Not Available	Cathedral & Half	-	-	-	-
	Not Available	Eyebrow & Half	-	-	-	-
	VFB	Reduced Rail Drawer	146mm	5 3/4	184mm	7 1/4



 <p>V-Groove Stile/Rail Soft Panel</p>	CODES	MINIMUM SIZES	Height		Width	
	VSS, VSS HG	Square, Full Drawer	184mm	7 1/4	184mm	7 1/4
	VSS4, VSS6L, VSS6R	Cathedral & Half	225mm	8 7/8	189mm	7 7/16
	VSS9, VSS10L, VSS10R	Eyebrow & Half	210mm	8 1/4	189mm	7 7/16
	VFS	Reduced Rail Drawer	146mm	5 3/4	184mm	7 1/4

 <p>V-Groove Stile/Rail Reversed Panel</p>	BP and VP	CODES	MINIMUM SIZES	Height		Width	
	Suffix "BP" or "VP" to Codes Directly to Right	VSR, VSR HG	Square, Full Drawer	130mm	5 1/8	140mm	5 1/2
		VSR4, VSR6L, VSR6R	Cathedral & Half	171mm	6 3/4	189mm	7 7/16
		VSR9, VSR10L, VSR10R	Eyebrow & Half	156mm	6 1/8	189mm	7 7/16
	VFR VGBP, VFR VGVP	VFR	Reduced Rail Drawer	92mm	3 5/8	140mm	5 1/2

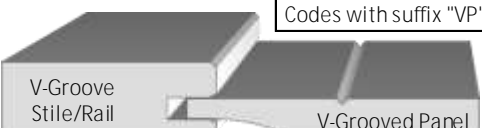
 <p>V-Groove Stile/Rail Beaded Panel</p>	Codes with suffix "BP"

 <p>V-Groove Stile/Rail V-Grooved Panel</p>	Codes with suffix "VP"

Drawer Front Options

Slab	Reduced Rail	Full Sized Rail
		
DFB - Drawer Front Blank	2 1/4" Stile with 1 1/2" Rail (codes starting with "D")	2 1/4" Stile and Rail (all codes with suffix "HG")

Bevel Shaker Stile/Rail with Optional Panels for Doors

See Page 21 for Outside Edge Profile Options

 <p>Bevel Shaker Stile/Rail</p>	Codes with Suffix "F" See Page 3 for Frame Options	CODES	MINIMUM SIZES	Height		Width	
		KS1 F	Square, Full Drawer	130mm	5 1/8"	140mm	5 1/2"
		Not Available	Cathedral & Half	-	-	-	-
		Not Available	Eyebrow & Half	-	-	-	-
		KF1 F	Reduced Rail Drawer	92mm	3 5/8"	140mm	5 1/2"

 <p>Bevel Shaker Stile/Rail Ply Panel</p>	CODES	MINIMUM SIZES	Height		Width	
	KS1, KS1 HG	Square, Full Drawer	130mm	5 1/8"	140mm	5 1/2"
	Not Available	Cathedral & Half	-	-	-	-
	Not Available	Eyebrow & Half	-	-	-	-
	KF1	Reduced Rail Drawer	92mm	3 5/8"	140mm	5 1/2"

 <p>Bevel Shaker Stile/Rail Cove Panel</p>	CODES	MINIMUM SIZES	Height		Width	
	KSC, KSC HG	Square, Full Drawer	173mm	6 13/16"	173mm	6 13/16"
	Not Available	Cathedral & Half	-	-	-	-
	Not Available	Eyebrow & Half	-	-	-	-
	KFC	Reduced Rail Drawer	135mm	5 5/16"	173mm	6 13/16"

 <p>Bevel Shaker Stile/Rail Multiwood Panel</p>	CODES	MINIMUM SIZES	Height		Width	
	KS3, KS3 HG	Square, Full Drawer	168mm	6 5/8"	168mm	6 5/8"
	Not Available	Cathedral & Half	-	-	-	-
	Not Available	Eyebrow & Half	-	-	-	-
	KF3	Reduced Rail Drawer	130mm	5 1/8"	168mm	6 5/8"

 <p>Bevel Shaker Stile/Rail Pearl Panel</p>	CODES	MINIMUM SIZES	Height		Width	
	KSP, KSP HG	Square, Full Drawer	184mm	7 1/4"	184mm	7 1/4"
	Not Available	Cathedral & Half	-	-	-	-
	Not Available	Eyebrow & Half	-	-	-	-
	KFP	Reduced Rail Drawer	146mm	5 3/4"	184mm	7 1/4"

 <p>Bevel Shaker Stile/Rail Bevel Panel</p>	CODES	MINIMUM SIZES	Height		Width	
	KSB, KSB HG	Square, Full Drawer	184mm	7 1/4"	184mm	7 1/4"
	Not Available	Cathedral & Half	-	-	-	-
	Not Available	Eyebrow & Half	-	-	-	-
	KFB	Reduced Rail Drawer	146mm	5 3/4"	184mm	7 1/4"

 <p>Bevel Shaker Stile/Rail Soft Panel</p>	CODES	MINIMUM SIZES	Height		Width	
	KSS, KSS HG	Square, Full Drawer	184mm	7 1/4"	184mm	7 1/4"
	Not Available	Cathedral & Half	-	-	-	-
	Not Available	Eyebrow & Half	-	-	-	-
	KFS	Reduced Rail Drawer	146mm	5 3/4"	184mm	7 1/4"

 <p>Bevel Shaker Stile/Rail Reversed Panel</p>	BP and VP	CODES	MINIMUM SIZES	Height		Width	
	Suffix "BP" or "VP" to Codes Directly to Right	KSR, KSR HG	Square, Full Drawer	130mm	5 1/8"	140mm	5 1/2"
		Not Available	Cathedral & Half	-	-	-	-
		Not Available	Eyebrow & Half	-	-	-	-
	KFR VGVP, KFR VGVP	KFR	Reduced Rail Drawer	92mm	3 5/8"	140mm	5 1/2"

 <p>Bevel Shaker Stile/Rail Beaded Panel</p>	Codes with suffix "BP"

 <p>Bevel Shaker Stile/Rail V-Grooved Panel</p>	Codes with suffix "VP"

Drawer Front Options

Slab



DFB - Drawer Front Blank

Reduced Rail

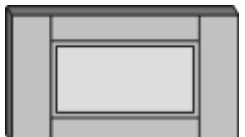

2 1/4" Stile with 1 1/2" Rail (codes starting with "D")

Full Sized Rail





2 1/4" Stile and Rail (all codes with suffix "HG")

Lip Stile/Rail with Optional Panels for Doors

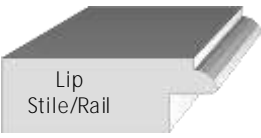
See Page 21 for Outside Edge Profile Options

 <p>Lip Stile/Rail</p>	Codes with Suffix "F" See Page 3 for Frame Options	CODES	MINIMUM SIZES	Height		Width	
		LS1 F	Square, Full Drawer	130mm	5 1/8	140mm	5 1/2
		LS2 F	Cathedral & Half	171mm	6 3/4	200mm	7 7/8
		LS8 F	Eyebrow & Half	156mm	6 1/8	200mm	7 7/8
		LF1 F	Reduced Rail Drawer	92mm	3 5/8	140mm	5 1/2

 <p>Lip Stile/Rail Ply Panel</p>	CODES	MINIMUM SIZES	Height		Width	
	LS1, LS1 HG	Square, Full Drawer	130mm	5 1/8	140mm	5 1/2
	LS2, LS5R, LS5L	Cathedral & Half	171mm	6 3/4	200mm	7 7/8
	LS8, LS7L, LS7R	Eyebrow & Half	156mm	6 1/8	200mm	7 7/8
	LF1	Reduced Rail Drawer	92mm	3 5/8	140mm	5 1/2

 <p>Lip Stile/Rail Cove Panel</p>	CODES	MINIMUM SIZES	Height		Width	
	LSC, LSC HG	Square, Full Drawer	173mm	6 13/16	173mm	6 13/16
	LSC4, LSC6L, LSC6R	Cathedral & Half	214mm	8 7/16	200mm	7 7/8
	LSC9, LSC10L, LSC10R	Eyebrow & Half	198mm	7 13/16	200mm	7 7/8
	LFC	Reduced Rail Drawer	135mm	5 5/16	173mm	6 13/16

 <p>Lip Stile/Rail Multiwood Panel</p>	CODES	MINIMUM SIZES	Height		Width	
	LS3, LS3 HG	Square, Full Drawer	168mm	6 5/8	168mm	6 5/8
	LS4, LS6L, LS6R	Cathedral & Half	210mm	8 1/4	200mm	7 7/8
	LS9, LS10L, LS10R	Eyebrow & Half	194mm	7 5/8	200mm	7 7/8
	LF3	Reduced Rail Drawer	130mm	5 1/8	168mm	6 5/8

 <p>Lip Stile/Rail Pearl Panel</p>	CODES	MINIMUM SIZES	Height		Width	
	LSP, LSP HG	Square, Full Drawer	184mm	7 1/4	184mm	7 1/4
	LSP4, LSP6L, LSP6R	Cathedral & Half	225mm	8 7/8	200mm	7 7/8
	LSP9, LSP10L, LSP10R	Eyebrow & Half	210mm	8 1/4	200mm	7 7/8
	LFP	Reduced Rail Drawer	146mm	5 3/4	184mm	7 1/4

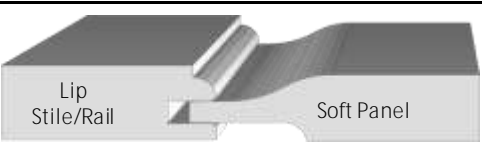

 <p>Lip Stile/Rail Bevel Panel</p>	CODES	MINIMUM SIZES	Height		Width	
	LSB, LSB HG	Square, Full Drawer	184mm	7 1/4	184mm	7 1/4
	Not Available	Cathedral & Half	-	-	-	-
	Not Available	Eyebrow & Half	-	-	-	-
	LFB	Reduced Rail Drawer	146mm	5 3/4	184mm	7 1/4

 <p>Lip Stile/Rail Soft Panel</p>	CODES	MINIMUM SIZES	Height		Width	
	LSS, LSS HG	Square, Full Drawer	184mm	7 1/4	184mm	7 1/4
	LSS4, LSS6L, LSS6R	Cathedral & Half	225mm	8 7/8	200mm	7 7/8
	LSS9, LSS10L, LSS10R	Eyebrow & Half	210mm	8 1/4	200mm	7 7/8
	LFS	Reduced Rail Drawer	146mm	5 3/4	184mm	7 1/4

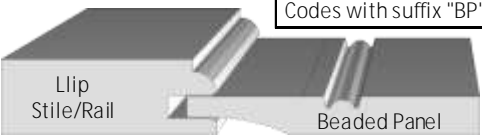
 <p>Lip Stile/Rail Reversed Panel</p>	BP and VP	CODES	MINIMUM SIZES	Height		Width	
	Suffix "BP" or "VP" to Codes Directly to Right	LSR, LSR HG	Square, Full Drawer	130mm	5 1/8	140mm	5 1/2
		LSR4, LSR6L, LSR6R	Cathedral & Half	171mm	6 3/4	200mm	7 7/8
		LSR9, LSR10L, LSR10R	Eyebrow & Half	156mm	6 1/8	200mm	7 7/8
	LFR VGB, LFR VGVP	LFR	Reduced Rail Drawer	92mm	3 5/8	140mm	5 1/2

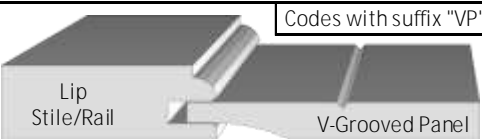
 <p>Lip Stile/Rail Beaded Panel</p>	Codes with suffix "BP"

 <p>Lip Stile/Rail V-Grooved Panel</p>	Codes with suffix "VP"

Drawer Front Options		
Slab	Reduced Rail	Full Sized Rail
 <p>DFB - Drawer Front Blank</p>	 <p>2 1/4" Stile with 1 1/2" Rail (codes starting with "D")</p>	 <p>2 1/4" Stile and Rail (all codes with suffix "HG")</p>

Bevel Stile/Rail with Optional Panels for Doors

See Page 21 for Outside Edge Profile Options

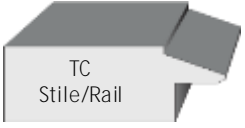
 <p>TC Stile/Rail</p>	Codes with Suffix "F" See Page 3 for Frame Options	CODES	MINIMUM SIZES	Height		Width	
		TC1 F	Square, Full Drawer	130mm	5 1/8	140mm	5 1/2
		Not Available	Cathedral & Half	171mm	6 3/4	200mm	7 7/8
		Not Available	EyebrTC & Half	156mm	6 1/8	200mm	7 7/8
		TF1 F	Reduced Rail Drawer	92mm	3 5/8	140mm	5 1/2

 <p>TC Stile/Rail Ply Panel</p>	CODES	MINIMUM SIZES	Height		Width		
	TC1, TC1 HG	Square, Full Drawer	130mm	5 1/8	140mm	5 1/2	
	Not Available	Cathedral & Half	171mm	6 3/4	200mm	7 7/8	
	Not Available	EyebrTC & Half	156mm	6 1/8	200mm	7 7/8	
		TCF1	Reduced Rail Drawer	92mm	3 5/8	140mm	5 1/2

 <p>TC Stile/Rail Cove Panel</p>	CODES	MINIMUM SIZES	Height		Width		
	TCC, TCC HG	Square, Full Drawer	173mm	6 13/16	173mm	6 13/16	
	Not Available	Cathedral & Half	214mm	8 7/16	200mm	7 7/8	
	Not Available	EyebrTC & Half	198mm	7 13/16	200mm	7 7/8	
		TCFC	Reduced Rail Drawer	135mm	5 5/16	173mm	6 13/16

 <p>TC Stile/Rail Multiwood Panel</p>	CODES	MINIMUM SIZES	Height		Width		
	TC3, TC3 HG	Square, Full Drawer	168mm	6 5/8	168mm	6 5/8	
	Not Available	Cathedral & Half	210mm	8 1/4	200mm	7 7/8	
	Not Available	EyebrTC & Half	194mm	7 5/8	200mm	7 7/8	
		TCF3	Reduced Rail Drawer	130mm	5 1/8	168mm	6 5/8

 <p>TC Stile/Rail Pearl Panel</p>	CODES	MINIMUM SIZES	Height		Width		
	TCP3, TCP3 HG	Square, Full Drawer	184mm	7 1/4	184mm	7 1/4	
	Not Available	Cathedral & Half	225mm	8 7/8	200mm	7 7/8	
	Not Available	EyebrTC & Half	210mm	8 1/4	200mm	7 7/8	
		TCFP	Reduced Rail Drawer	146mm	5 3/4	184mm	7 1/4

 <p>TC Stile/Rail Bevel Panel</p>	CODES	MINIMUM SIZES	Height		Width		
	TCB, TCB HG	Square, Full Drawer	184mm	7 1/4	184mm	7 1/4	
	Not Available	Cathedral & Half	-	-	-	-	
	Not Available	EyebrTC & Half	-	-	-	-	
		TCFB	Reduced Rail Drawer	146mm	5 3/4	184mm	7 1/4

 <p>TC Stile/Rail Soft Panel</p>	CODES	MINIMUM SIZES	Height		Width		
	TCS, TCS HG	Square, Full Drawer	184mm	7 1/4	184mm	7 1/4	
	Not Available	Cathedral & Half	225mm	8 7/8	200mm	7 7/8	
	Not Available	EyebrTC & Half	210mm	8 1/4	200mm	7 7/8	
		TCFS	Reduced Rail Drawer	146mm	5 3/4	184mm	7 1/4

 <p>TC Stile/Rail Reversed Panel</p>	BP and VP	CODES	MINIMUM SIZES	Height		Width	
	Suffix "BP" or "VP" to Codes Directly to Right TCFR VGBP,TCFR VGVP	TCR, TCR HG	Square, Full Drawer	130mm	5 1/8	140mm	5 1/2
		Not Available	Cathedral & Half	171mm	6 3/4	200mm	7 7/8
		Not Available	EyebrTC & Half	156mm	6 1/8	200mm	7 7/8
		TCFR	Reduced Rail Drawer	92mm	3 5/8	140mm	5 1/2

 <p>TC Stile/Rail Beaded Panel</p>	Codes with suffix "BP"

 <p>TC Stile/Rail V-Grooved Panel</p>	Codes with suffix "VP"

Drawer Front Options

Slab



DFB - Drawer Front Blank

Reduced Rail



2 1/4" Stile with 1 1/2" Rail
(codes starting with "D")

Full Sized Rail



2 1/4" Stile and Rail (all codes with suffix "HG")

Height	x	Width	sq. in	MW1/MS1		MW2		MW3		MW4		MWR/MSR/MC3	
				c/sq. in	Door	c/sq. in	Door	c/sq. in	Door	c/sq. in	Door	c/sq. in	Door
13"	x	8 1/2"	111	0.22	\$24.39	0.22	\$24.39	0.35	\$38.85	0.35	\$38.85	0.37	\$40.80
13"	x	14 1/2"	189	0.16	\$30.15	0.16	\$30.15	0.26	\$48.50	0.26	\$48.50	0.27	\$50.92
13"	x	20 1/2"	267	0.13	\$34.97	0.13	\$34.97	0.22	\$58.17	0.22	\$58.17	0.23	\$61.08
16"	x	8 1/2"	136	0.20	\$27.16	0.20	\$27.16	0.31	\$42.23	0.31	\$42.23	0.33	\$44.34
16"	x	14 1/2"	232	0.14	\$33.06	0.14	\$33.06	0.23	\$54.29	0.23	\$54.29	0.25	\$57.01
16"	x	20 1/2"	328	0.12	\$39.44	0.12	\$39.44	0.20	\$65.51	0.20	\$65.51	0.21	\$68.79
18"	x	8 1/2"	153	0.19	\$28.49	0.19	\$28.49	0.29	\$44.89	0.29	\$44.89	0.31	\$47.13
18"	x	14 1/2"	261	0.14	\$35.23	0.14	\$35.23	0.21	\$55.49	0.21	\$55.49	0.22	\$58.26
18"	x	20 1/2"	369	0.11	\$42.23	0.11	\$42.23	0.18	\$68.04	0.18	\$68.04	0.19	\$71.45
21 1/4"	x	8 1/2"	181	0.17	\$30.43	0.17	\$30.43	0.27	\$47.69	0.27	\$47.69	0.28	\$50.07
21 1/4"	x	14 1/2"	308	0.12	\$37.90	0.12	\$37.90	0.20	\$62.25	0.20	\$62.25	0.21	\$65.37
21 1/4"	x	20 1/2"	436	0.11	\$45.66	0.11	\$45.66	0.18	\$77.76	0.18	\$77.76	0.19	\$81.65
23 1/2"	x	8 1/2"	200	0.17	\$34.25	0.17	\$34.25	0.24	\$49.28	0.24	\$49.28	0.25	\$51.74
23 1/2"	x	14 1/2"	341	0.12	\$41.65	0.12	\$41.65	0.19	\$66.55	0.19	\$66.55	0.20	\$69.88
23 1/2"	x	20 1/2"	482	0.10	\$50.40	0.10	\$50.40	0.17	\$84.92	0.17	\$84.92	0.18	\$89.16
28"	x	8 1/2"	238	0.16	\$36.92	0.16	\$36.92	0.22	\$53.08	0.22	\$53.08	0.23	\$55.73
28"	x	14 1/2"	406	0.11	\$46.32	0.11	\$46.32	0.18	\$73.69	0.18	\$73.69	0.19	\$77.38
28"	x	20 1/2"	574	0.10	\$55.98	0.10	\$55.98	0.16	\$94.20	0.16	\$94.20	0.17	\$98.91
30 1/2"	x	8 1/2"	259	0.14	\$39.35	0.14	\$39.35	0.21	\$58.23	0.21	\$58.23	0.22	\$61.14
30 1/2"	x	14 1/2"	442	0.11	\$49.50	0.11	\$49.50	0.18	\$83.04	0.18	\$83.04	0.19	\$87.20
30 1/2"	x	20 1/2"	625	0.09	\$60.24	0.09	\$60.24	0.16	\$107.87	0.16	\$107.87	0.17	\$113.26

Custom Size Wood Door Pricing

Pricing Custom Height - Using door size that is closest to your door size, but smaller, find the square inch price for the right style of door. Now multiply the height by the width by the square inch price listed, rounding up dimensions to the next full inch.

Pricing Custom Width - Calculate the same as Custom Height adding 15% to the cost.

Please Note: The calculations above are for estimating purposes only, contact the order desk for an exact price.

MH mitered door styles are 30% more than their respective standard door styles.

MT, ML and MN mitered door styles are 25% more than their respective standard door styles.

MG, MJ, MK, MR and MX mitered door styles are 20% more than their respective standard door styles.

V-Grooved and Beaded Panels add \$7.00 per door.

V-Groove through Stile & Rail add \$7.00 per door.

Solid Slab Drawer Pricing

DFB (Solid Slab) Pricing

Multiply length by price. Prices are based on Oak. Multiply price shown by wood factor (see page 2) for other species.

Width	Price per Lineal Inch	Width	Price per Lineal Inch
up to 4"	0.60	up to 9"	1.41
up to 5"	0.76	Up to 10"	1.57
up to 6"	0.92	Up to 11"	1.72
up to 7"	1.08	Up to 12"	1.89
up to 8"	1.24	Up to 13"	2.05

Frame Pricing

To determine a frames price, start from the same style of flat panel door and add the up-charge cost. Frame styles illustrated on Page3.

Type	Charge
F	\$0.00
F4	\$15.27
F6	\$22.39
F8	\$32.56
F9	\$36.63
F10	\$43.75
F12	\$50.88

Frame pricing is based on Oak, MDF or Knotty Pine. Please multiply by wood factor to determine pricing for other material types.

MT Doors:

MT3 Door DT3 Drawer

MT Style/Rail (Door) Multiwood Panel DT Style/Rail (Drawer)

3" (76.2mm) 1 7/8" (47.6mm)

MT1 Door MT3 Door MTP Door

MT Style/Rail + Ply Panel MT Style/Rail + Cove Panel MT Style/Rail + Pearl Panel

MTS Door MTB Door MTR Door

MT Style/Rail + Soft Panel MT Style/Rail + Bevel Panel MT Style/Rail + Reversed Panel (Available in Beaded or V-Groove)

Minimum Sizes		
Codes	Height & Width	
MT1	168mm	6 5/8
MT3	206mm	8 1/8
MTC	211mm	8 5/16
MTR	200mm	7 7/8
MTP,MTB,MTS	222mm	8 3/4
DT1	127mm	5
DT3	149mm	5 7/8
DTC	154mm	6 1/16
DTR	127mm	5
DTP,DTB,DTS	165mm	6 1/2

See Page 3 for Frame Options. For Full Size Rail Drawer Fronts, Add Suffix "HG" to Door Code

MN Doors:

MN3 Door DN3 Drawer

MN Style/Rail (Door) Multiwood Panel DN Style/Rail (Drawer)

3" (76.2mm) 1 3/4" (44.5mm)

MN1 Door MN3 Door MNP Door

MN Style/Rail + Ply Panel MN Style/Rail + Cove Panel MN Style/Rail + Pearl Panel

MNS Door MNB Door MNR Door

MN Style/Rail + Soft Panel MN Style/Rail + Bevel Panel MN Style/Rail + Reversed Panel (Available in Beaded or V-Groove)

Minimum Sizes		
Codes	Height & Width	
MN1	168mm	6 5/8
MN3	206mm	8 1/8
MNC	211mm	8 5/16
MNR	200mm	7 7/8
MNP,MNB,MNS	222mm	8 3/4
DN1	127mm	5
DN3	143mm	5 5/8
DNC	148mm	5 13/16
DNR	127mm	5
DNP,DNB,DNS	159mm	6 1/4

See Page 3 for Frame Options. For Full Size Rail Drawer Fronts, Add Suffix "HG" to Door Code

MR Doors:

MR3 Door DR3 Drawer

MR Style/Rail (Door) Multiwood Panel DR Style/Rail (Drawer)

2 1/4" (57.2mm) 1 3/4" (44.5mm)

MR1 Door MR3 Door MRP Door

MR Style/Rail + Ply Panel MR Style/Rail + Cove Panel MR Style/Rail + Pearl Panel

MRS Door MRB Door MRR Door

MR Style/Rail + Soft Panel MR Style/Rail + Bevel Panel MR Style/Rail + Reversed Panel (Available in Beaded or V-Groove)

Minimum Sizes		
Codes	Height & Width	
MR1	130mm	5 1/8
MR3	168mm	6 5/8
MRC	173mm	6 13/16
MRR	130mm	5 1/8
MRP,MRB,MRS	184mm	7 1/4
DR1	127mm	5
DR3	143mm	5 5/8
DRC	148mm	5 13/16
DRR	127mm	5
DRP,DRB,DRS	159mm	6 1/4

See Page 3 for Frame Options. For Full Size Rail Drawer Fronts, Add Suffix "HG" to Door Code

MX Doors:

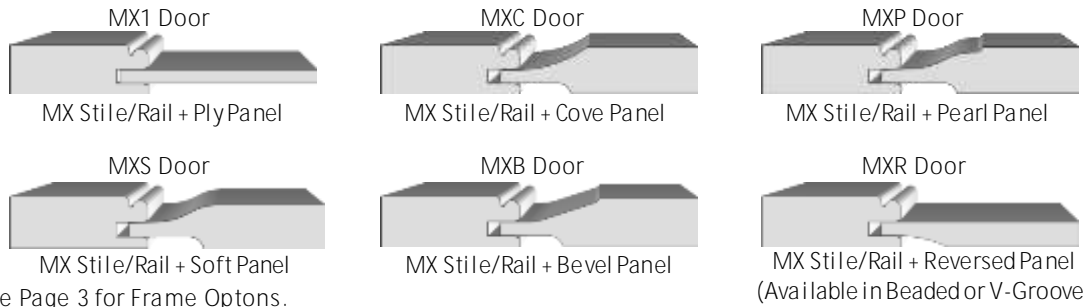
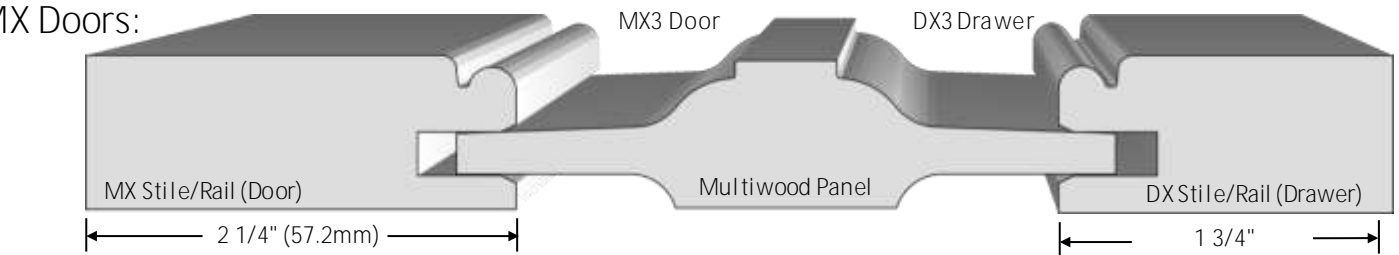

Minimum Sizes		
Codes	Height	Width
MX1	130mm	5 1/8"
MX3	168mm	6 5/8"
MXC	173mm	6 13/16"
MXR	130mm	5 1/8"
MXP, MXB, MXS	184mm	7 1/4"
DX1	127mm	5"
DX3	143mm	5 5/8"
DXC	148mm	5 13/16"
DXR	127mm	5"
DXP, DXB, DXS	159mm	6 1/4"

See Page 3 for Frame Options.

For Full Size Rail Drawer Fronts, Add Suffix "HG" to Door Code. (MX is Available with Outside Edge Profile)

ML Doors:

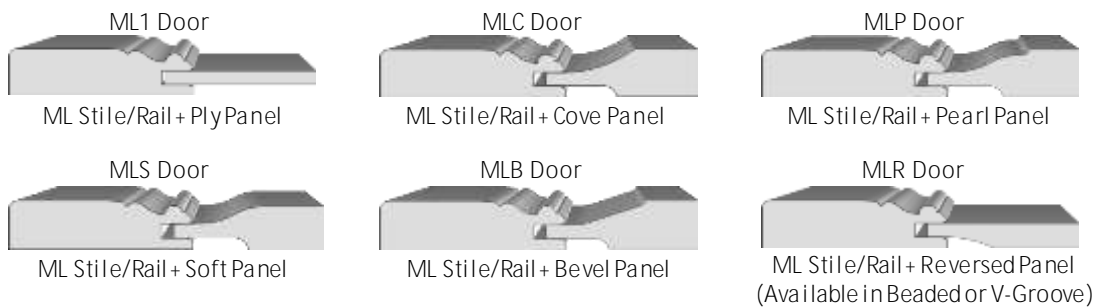
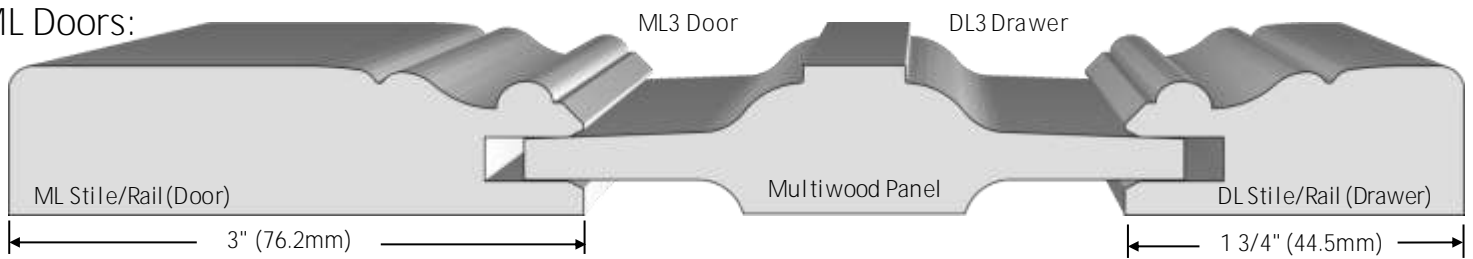

Minimum Sizes		
Codes	Height	Width
ML1	168mm	6 5/8"
ML3	206mm	8 1/8"
MLC	211mm	8 5/16"
MLR	200mm	7 7/8"
MLP, MLB, MLS	222mm	8 3/4"
DL1	127mm	5"
DL3	143mm	5 5/8"
DLC	148mm	5 13/16"
DLR	127mm	5"
DLP, DLB, DLS	159mm	6 1/4"

See Page 3 for Frame Options. For Full Size Rail Drawer Fronts, Add Suffix "HG" to Door Code

MH Doors:

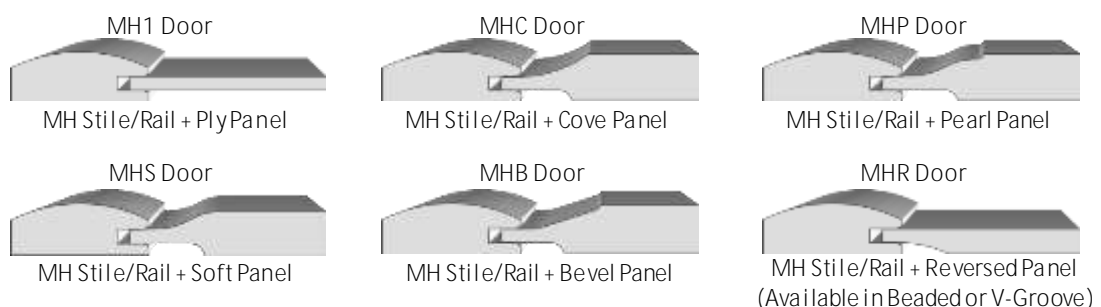
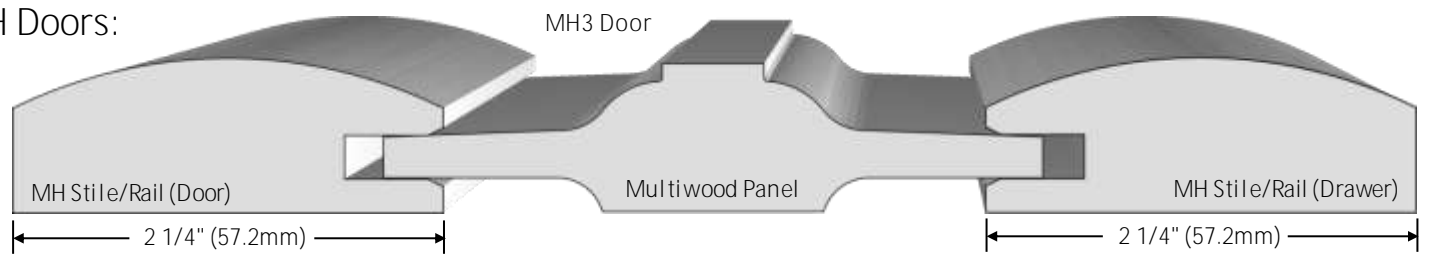

Minimum Sizes		
Codes	Height	Width
MH1	130mm	5 1/8"
MH3	168mm	6 5/8"
MHC	173mm	6 13/16"
MHR	130mm	5 1/8"
MHP, MHB, MHS	184mm	7 1/4"

See Page 3 for Frame Options. For Full Size Rail Drawer Fronts, Add Suffix "HG" to Door Code

MU Doors

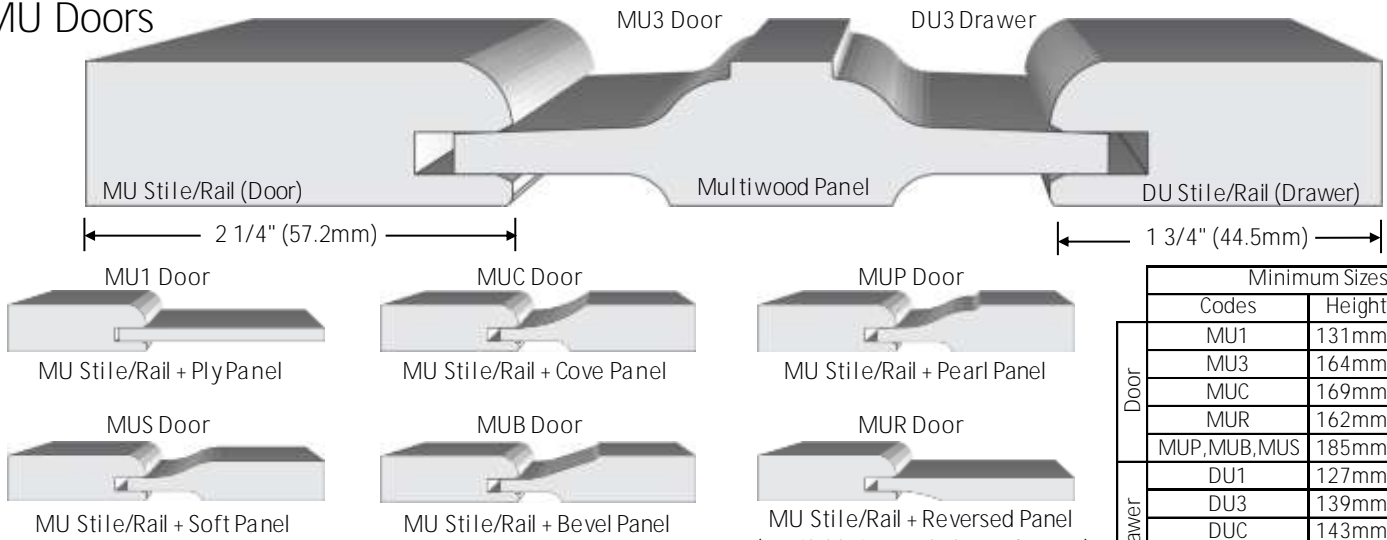

Minimum Sizes		
Codes	Height	Width
MU1	131mm	5 1/8"
MU3	164mm	6 7/16"
MUC	169mm	5 5/8"
MUR	162mm	6 3/8"
MUP, MUB, MUS	185mm	7 1/4"
DU1	127mm	5"
DU3	139mm	5 7/16"
DUC	143mm	5 5/8"
DUR	137mm	5 3/8"
DUP, DUB, DUS	159mm	6 1/4"

See Page 3 for Frame Options.

For Full Size Rail Drawer Fronts, Add Suffix "HG" to Door Code. (MU is Available with Outside Edge Profile)

Custom Mitered Doors

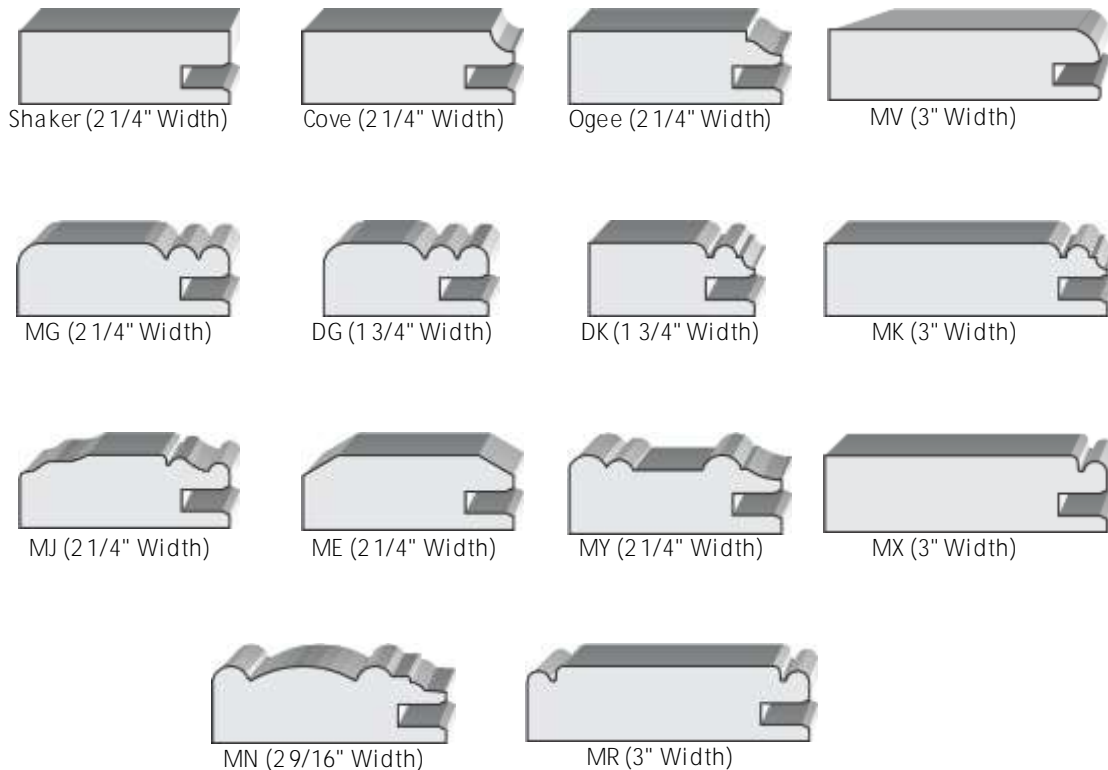

Custom Mitered Doors like the ones shown here can be ready for delivery in 3 weeks. Set-up charges will apply. Available with any of our panel options.

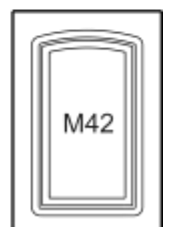
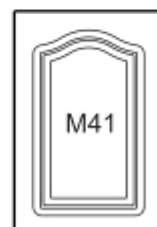
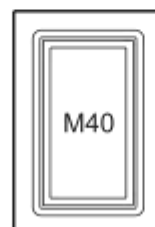
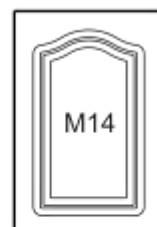
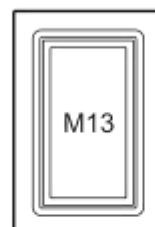
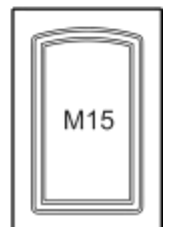
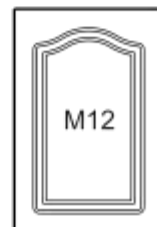
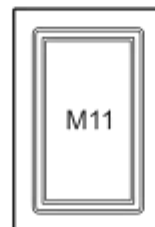
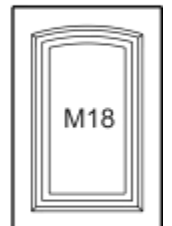
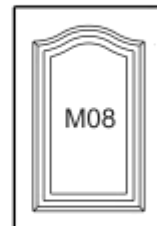
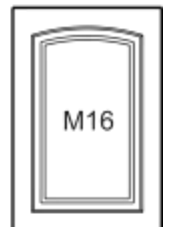
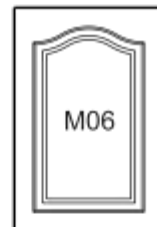
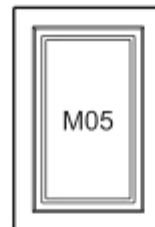
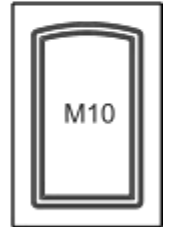
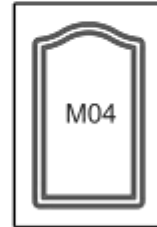
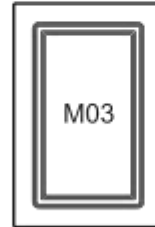
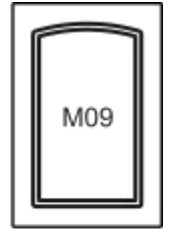
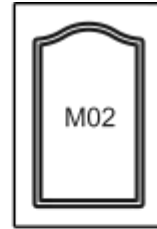
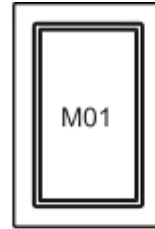
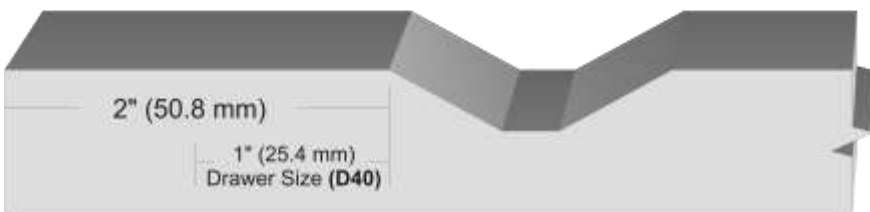
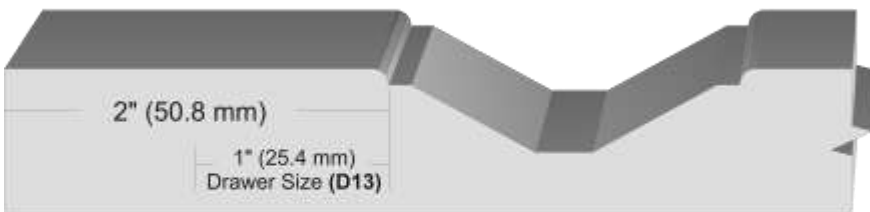
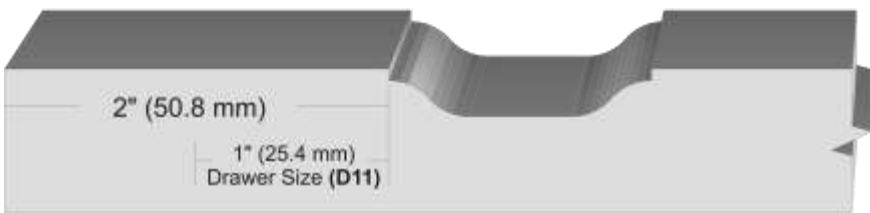
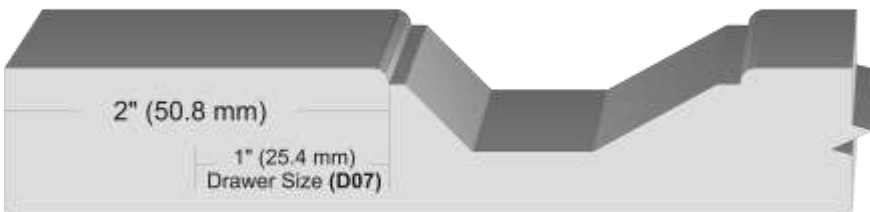
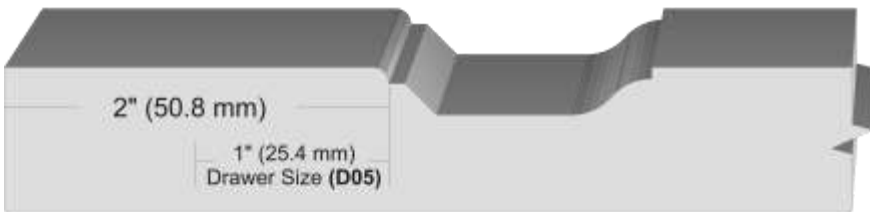
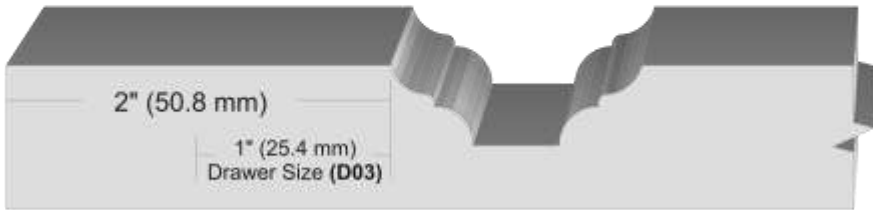
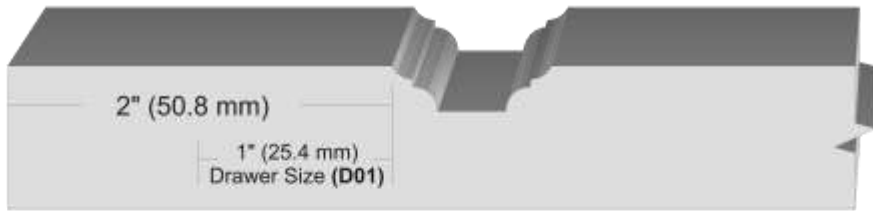



M32 2 pc. Shaker Panel Recessed 1/4"



M89 2 pc. Cove Recessed Panel

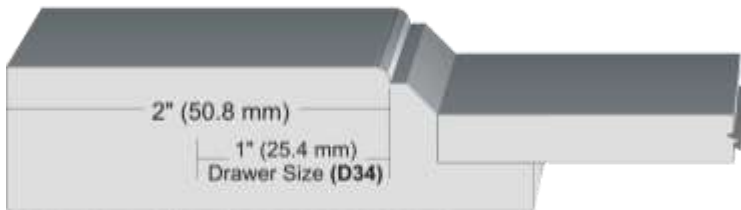

M34 2 pc. Chamfer Recessed Panel

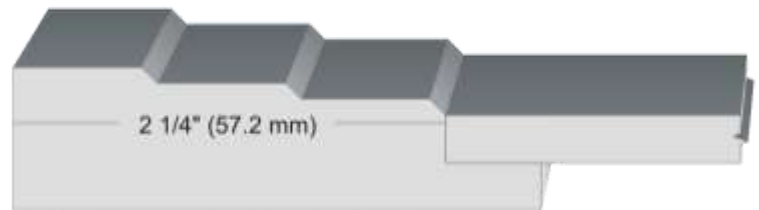

M92 2 pc. Step Recessed Panel



M38 2 pc. Shaker Panel Recessed 3/8"



M94 2 pc. Recessed Panel Beaded Stile and Rail

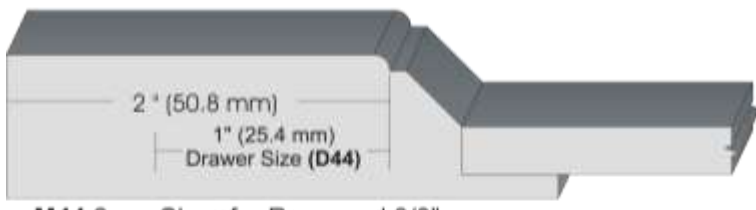

M44 2 pc. Chamfer Recessed 3/8"



M95 Beaded (Washboard) Raised Panel

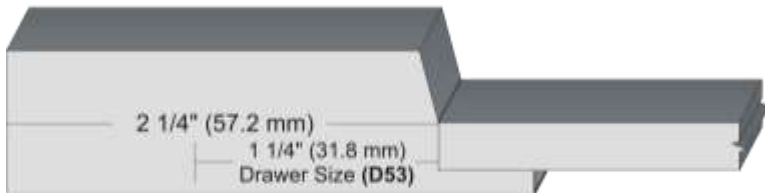

M53 2 pc. Bevel Shaker Recessed 3/8"



M96 V-Groove Panel & V-Groove Through Stile and Rail
M86 V-Groove Raised Panel (Square Pattern Routed Only)



M70 Cove Panel

MDF Doors	
Style	\$/sq.ft.
M00	9.33
M01	11.55
M02	11.77
M03	11.77
M04	12.14
M05	14.96
M06	15.25
M07	15.25
M08	15.47
M09	11.77
M10	12.14
M11	12.14
M12	12.43
M13	12.14
M14	12.43
M15	12.43
M16	15.25
M17	12.43
M18	15.47
M32	14.96
M34	16.43
M44	16.43
M53	16.43
M70	15.47
M86	#N/A
M89	#N/A
M92	#N/A
M94	#N/A
M95	#N/A
M96	#N/A

Minimum Sizes - MDF Doors & Drawers					
Minimum Height				Minimum Width	
Drawers		Doors		Doors/Drawers	
Imperial	Metric	Imperial	Metric	Imperial	Metric
4 5/16	110mm	6 5/16	160mm	6 5/16	160mm
		7 15/16	202mm	6 5/16	160mm
5 1/4	133mm	7 1/4	184mm	7 1/4	184mm
		8 7/8	225mm	7 1/4	184mm
5 3/8	137mm	7 3/8	187mm	7 3/8	187mm
		9	229mm	7 3/8	187mm
6 5/16	160mm	8 5/16	211mm	8 5/16	211mm
		9 15/16	252mm	8 5/16	211mm
		7 9/16	192mm	6 1/4	159mm
		8 1/2	216mm	7 1/4	184mm
5 3/8	137mm	7 3/8	187mm	7 3/8	187mm
		9	229mm	7 3/8	187mm
6 5/16	160mm	8 5/16	211mm	8 5/16	211mm
		9 15/16	252mm	8 5/16	211mm
		8 5/8	219mm	7 3/8	187mm
		8 5/8	219mm	7 3/8	187mm
		9 9/16	243mm	8 5/16	211mm
		8 5/16	211mm	8 5/16	211mm
3 1/4	83mm	5 1/4	133mm	5 1/4	133mm
3 1/4	83mm	5 1/4	133mm	5 1/4	133mm
3 1/4	83mm	5 1/4	133mm	5 1/4	133mm
3 1/4	83mm	5 1/4	133mm	5 1/4	133mm
5 7/16	138mm	7 7/16	189mm	7 7/16	189mm
3 3/8	86mm	5 3/8	137mm	5 3/8	137mm
3 1/4	83mm	5 1/4	133mm	5 1/4	133mm
3 1/4	83mm	5 1/4	133mm	5 1/4	133mm
3 1/4	83mm	5 1/4	133mm	5 1/4	133mm
3 1/2	89mm	5 1/2	140mm	5 1/2	140mm
3 3/8	86mm	5 3/8	137mm	5 3/8	137mm

Cabinet Door and Drawer Height Combinations

Cabinet Door and Drawer Heights					
Box height	1 Door	1 Drawer	1 Door	3 Drawers	4 Drawers
384 (15 1/8")	382 (15 1/16")				
672 (26 7/16")	670 (26 3/8")				
704 (27 11/16")	702 (27 5/8")	189 (7 7/16")	510 (20 1/16")	189 (7 7/16") 2-254 (10")	
768 (30 1/4")	765 (30 1/8")	189 (7 7/16")	574 (22 9/16")	189 (7 7/16") 2-286 (11 1/4")	4 - 189 (7 7/16")
800 (31 1/2")	797 (31 3/8")	189 (7 7/16")	606 (23 7/8")	189 (7 7/16") 2-302 (11 7/8")	1-189 (7 7/16") 3-200 (7 7/8")
1088 (42 13/16")	1086 (42 3/4")				
1376 (54 3/16")	1374 (54 1/8")				
2048 (80 5/8")	2046 (80 9/16")				

Variations in Door and Drawer heights are possible in increments of 32mm (1 1/4"). If you want to reduce drawer height by 32mm (1 1/4"), add 32mm (1 1/4") to door. This will allow for the standard drilling of the doors to line up with the components.

	Box Height	Drawer	1 Door
Standard	800 (31 1/2")	189 (7 7/16")	606 (23 7/8")
		minus 32 (1 1/4")	add 32 (1 1/4")
e.g.	800 (31 1/2")	157 (6 3/16")	638 (25 1/8")



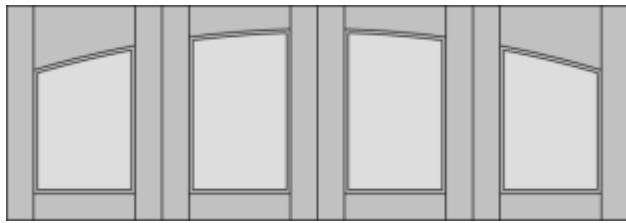

Arched Inside

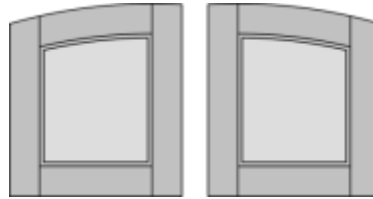

Arched Outside

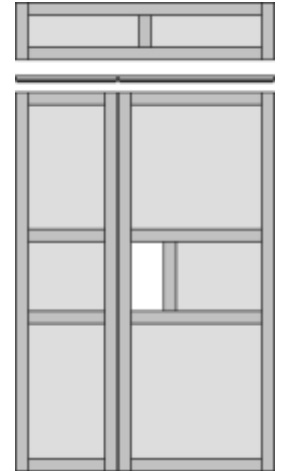

Fridge Panel

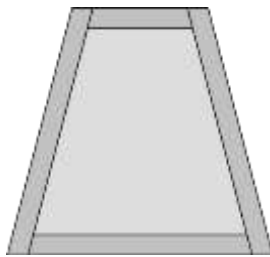

Vent Hoods

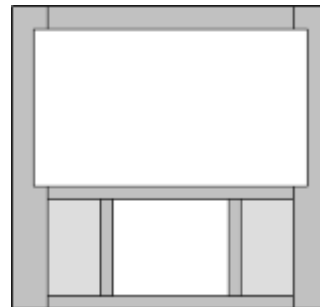

TV Cut-out

Speaker Grill & Glass Options

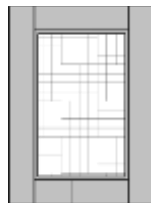

Example of Speaker Grills Available with Vinyl & Groove

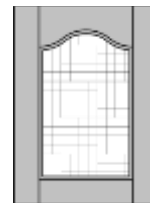

3mm Glass

Vinyl & Groove Option



Vinyl & Groove to wrap speaker cloth to



Cloth Grill Insert (MDF) to wrap speaker cloth to

For all Standard Wood, MDF and "MX" Mitered Doors

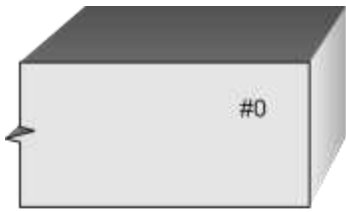

#0
Standard
(No Charge)

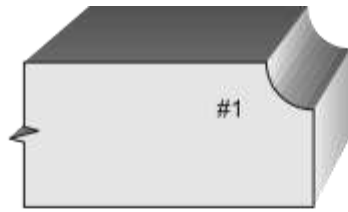

#1
1/4" Cove

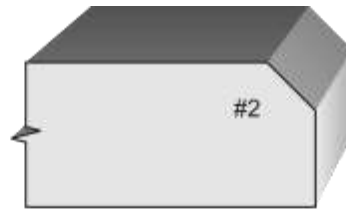

#2
1/4" Chamfer

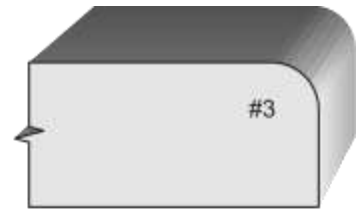

#3
1/4" Round



#4
3/8" Round

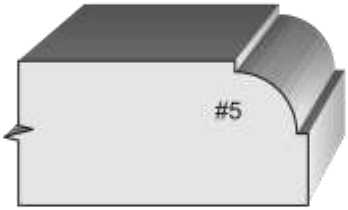

#5
3/8" Bead
(3mm Drill Not Available)

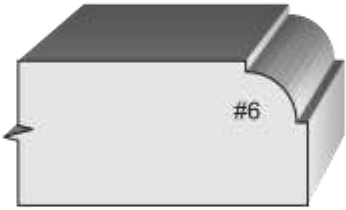

#6
1/4" Bead

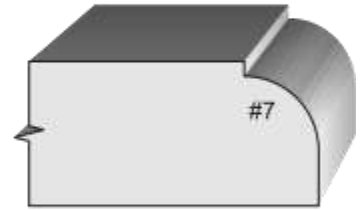

#7
3/8" Lip

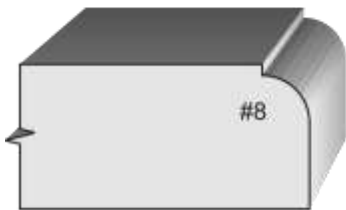

#8
1/4" Lip

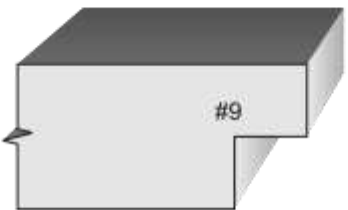

#9
Back Rabbet



#10
Flat Cove



#11
Flat Ogee
3mm Drill Not Available



#12
Finger Pull



#13
1/8" Round



#14
1/8" Chamfer



#16
MW Ogee



#17
1/8" Lip



#18
1/16" Round



#23
Outside Bead
(MDF Only)



#25
1/8 Notch



#26
Large Radius



#27
1/2" Round Over



#31
Cove Finger Pull

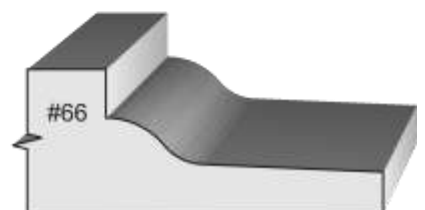

#66
Sub Zero

Plywood Door .5mm Edge PLY



Summary :

- 3/4" (19.1mm) thick Veneer on Particle Board core
- Edges are edge-taped using .5mm veneer edge tape.

Species :

- Oak
- Cherry
- Maple
- Others (call for availability)

Frame Option :

- Use shaker wood frame of same wood type or Center cut out with interior edges taped.



PLY
PLYWOOD DOOR
.5MM EDGE

Plywood Door 3mm Edge PLY3



Summary :

- 3/4" (19.1mm) thick Veneer on Particle Board core
- Edges are edge-taped using 1/8" (3mm) veneer edge tape.

Species :

- Oak
- Cherry
- Maple
- Others (call for availability)

Frame Option :

- Use shaker wood frame of same wood type with #13 profile on face and back or Center cut out with interior edges taped.



PLY3
PLYWOOD DOOR
3MM EDGE

Melamine Door .5mm Edge MEL



Summary :

- 3/4" (19.1mm) thick PB core slab melamine door.
- Matching Melamine Back
- Edges are edge-taped using .5mm pvc edge tape.

Available in :

- White (MEL)
- Classice Maple (MEL)
- Others (call for availability)

Frame Option :

- Center cut out with interior edges taped.

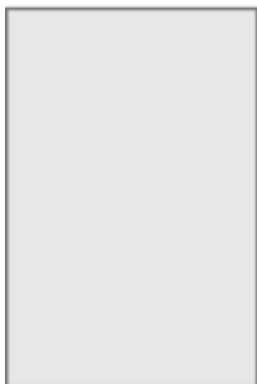

MEL
MELAMINE DOOR
.5MM EDGE

Melamine Door 3mm Edge MEL3

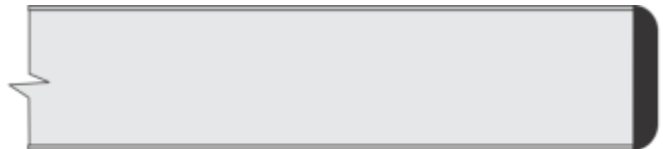

Summary :

- 3/4" (19.1mm) thick PB core slab melamine door.
- Matching Melamine Back
- Edges are edge-taped using 3mm pvc edge tape.

Available in :

- White (MEL3)
- Classice Maple (MEL3)
- Others (call for availability)

Frame Option :

- Center cut out with interior edges taped.



MEL3
MELAMINE DOOR
3MM EDGE

Multiwood offers 3 basic drilling types for all our doors Please specify the type needed at time of order Custom drill styles are also available (pending approval) Please ask salesperson for details Hinge drilling matches our Ferrari Clip-On Hinges

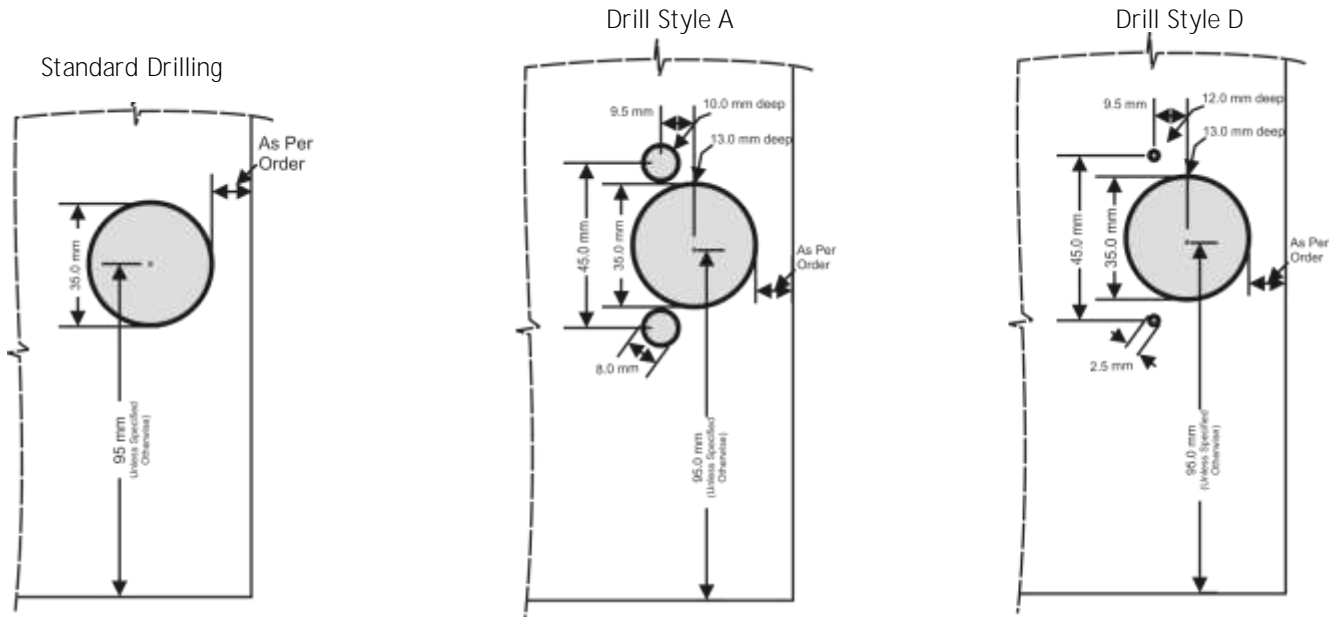

Diameter: 35 mm
 Offset: typical 5mm from edge of door or your spec.
 Height: 95mm from door top & bottom to center of holes.
 Drilling Height and Offset are Adjustable

Drilling for European Hinges:
Ferrari pattern
 Same as standard with:
 Two holes for plastic knock-in dowels
 Diameter: 8.0 mm

Drilling for European Hinges:
Ferrari pattern
 Same as standard with:
 Two Pilot holes for screws
 Diameter: 2.5 mm

3 hinges recommended for doors greater than 42" / * Please consult your particular hinge manufacturers specs before ordering.

Hand Rail & Bracket

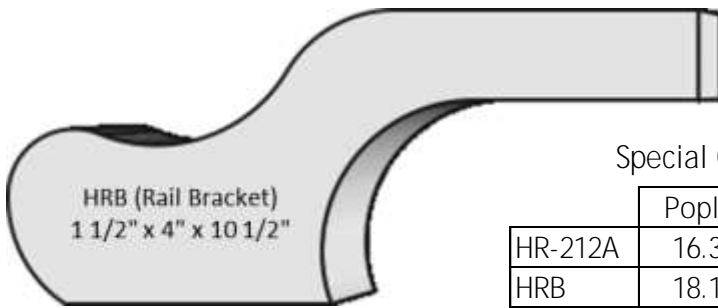

Special Order

	Poplar	Maple
HR-212A	16.35	19.68
HRB	18.14	28.01



Wine Racks

Available in all wood types and MDF. Made from Solid wood 3/4" thick, to your specifications. H=grain direction.

Large pieces can be made from MDF core plywood in various wood types as available.

Comes as a pair (front and back).

WNRK Diamond Style

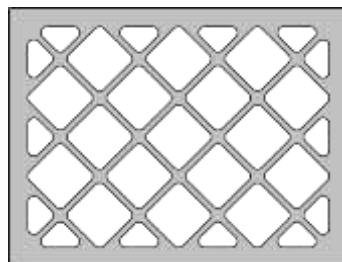

WAVE Style - Special Order

Sold in 8 Foot Lengths as pairs (front and back)

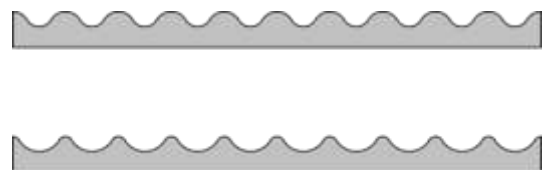

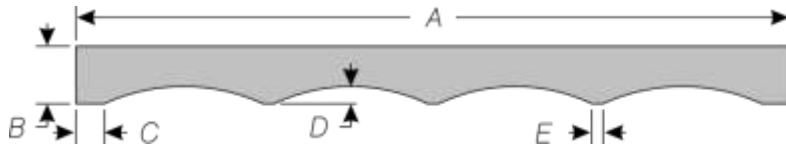

Specify All Dimensions, including
 F = number of arches
 Available in all wood types + MDF.
 Custom Styles also available.

Scr

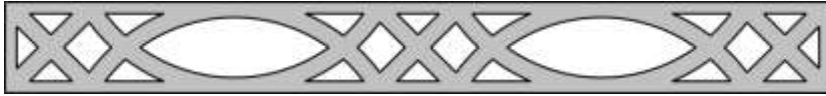

Scrollings can be Through cut or Face cut. Add a minimum 1" to size for 1/2" border. Custom Sizes Also Available.

Standard Scrolling Sizes				
Height	Width			
2 1/2	10	16	24	34
3 1/2	12	18	26	36
4 1/2	14	20	28	38

Cold Air Returns

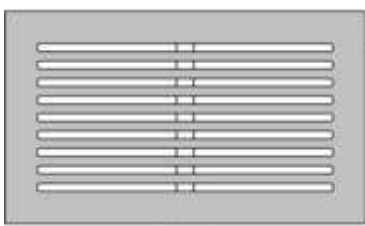

Plain

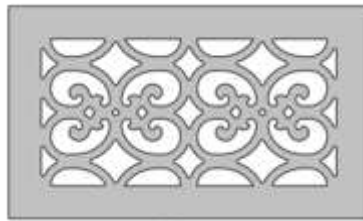

Fancy

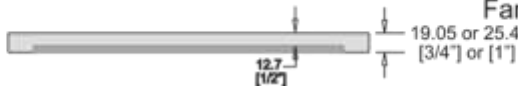

Standard Cold Air Return				
Height	Thick	Width		
8 1/4	1	16	24	32

MDF Plain Cold Air Return Pricing				
Code	Thick	Height	Width	Price
COLD16MDF	1	8 1/4	16	26.05
COLD24MDF	1	8 1/4	24	35.95
COLD32MDF	1	8 1/4	32	52.70

Cold Air returns are available in standard wood types as well as MDF. There are two styles, plain and fancy.

Custom Fluted Columns



Custom sized columns are available in either dish or v-groove styles single sided or double sided. Please call with your dimensions for pricing.

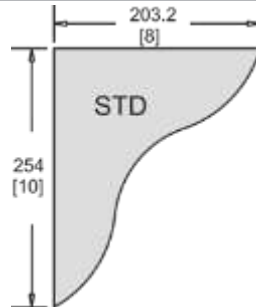

Standard Stock Item
 Shelf brackets are available in all wood types and MDF. Available in 1-1/2" thick. Stocking Oak, Maple, Cherry. Others by Special Order.

Custom corbels and custom size shelf brackets also available by special order.

Code	Wood	Price
SHBLALD	Alder	39.05
SHBLOAK	Oak	35.66
SHBLCHY	Cherry	39.27
SHBLMPL	Maple	35.66
SHBLPOP	Poplar	32.77

Shelf Brackets / Corbels

Bread

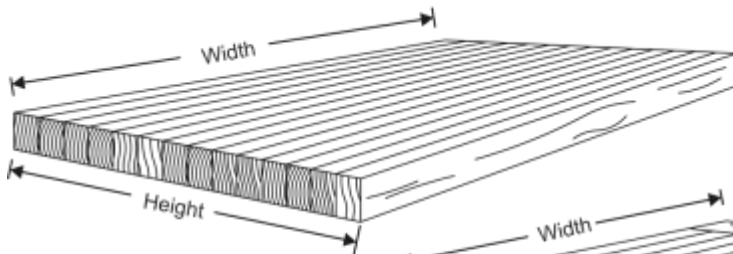

Butcher Block Tops (G1S)
 3/4" - 4" Thick
 (13/16" Laminations)

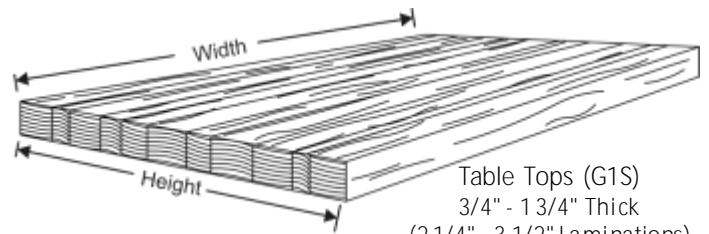
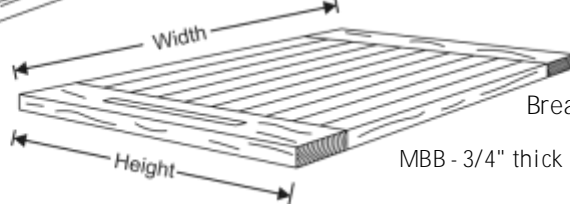

Table Tops (G1S)
 3/4" - 1 3/4" Thick
 (2 1/4" - 3 1/2" Laminations)



Bread Boards
 MBB - 3/4" thick

Butcher Blocks & Table Tops are G1S unless otherwise required

Multiwood's interior passage doors are available in Standard + MDF door profiles. They are built out of solid MDF or wood. Open frames or frames and mullion are also available. MDF passage doors are built with solid wood insert for hinge attachment. Doors illustrated below are examples only and can be modified to your specifications. Send Us your design for quotation.

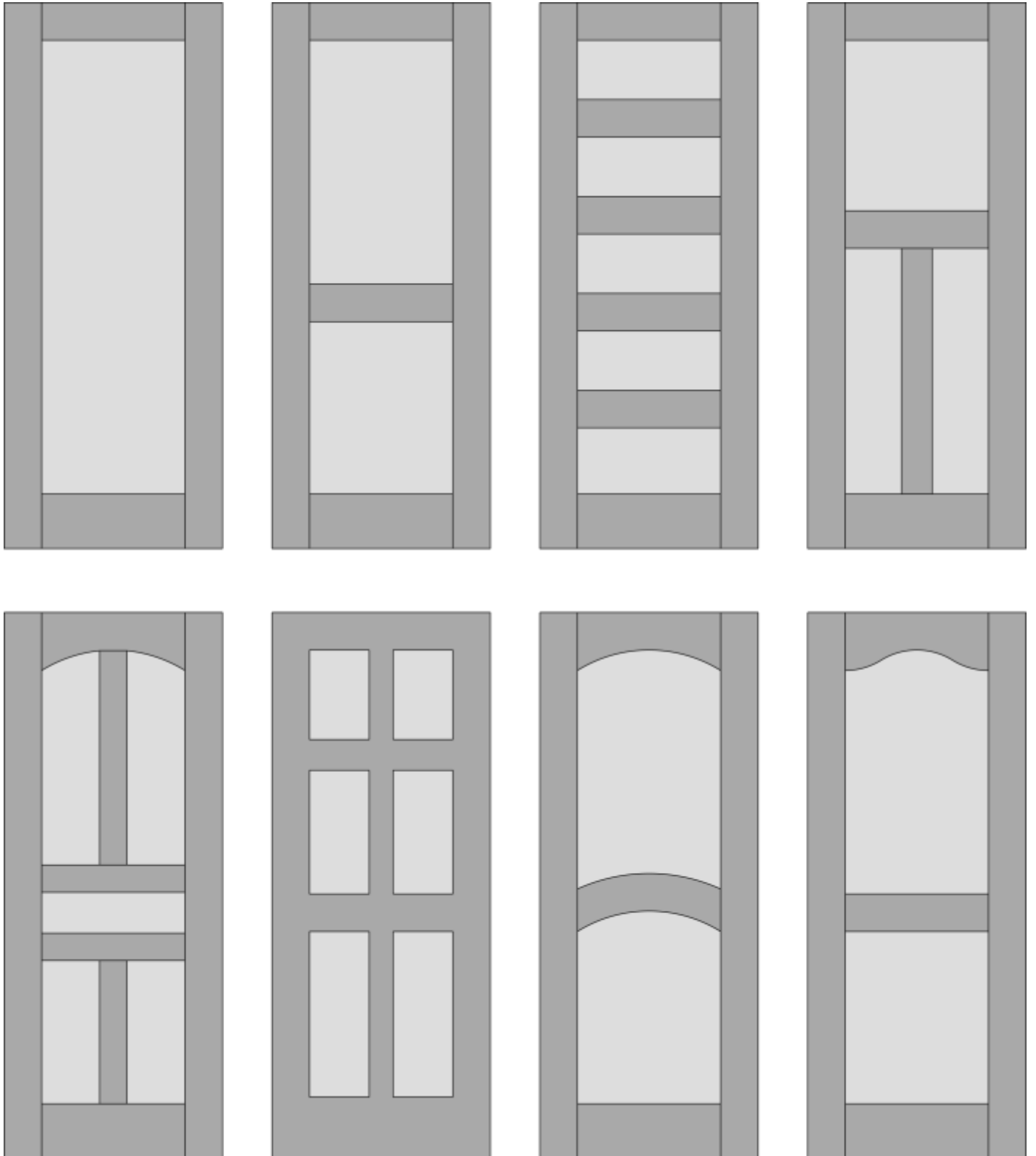

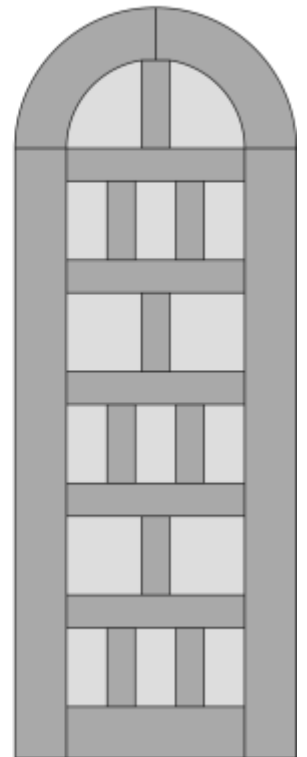
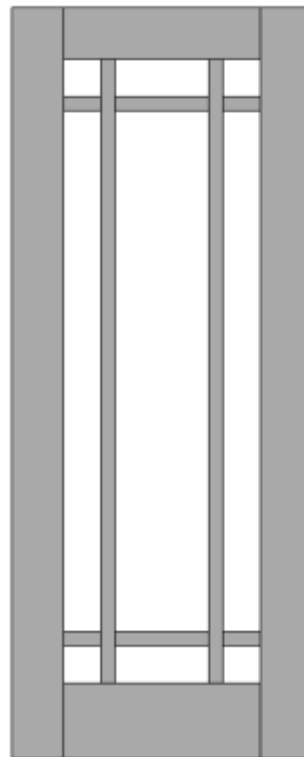
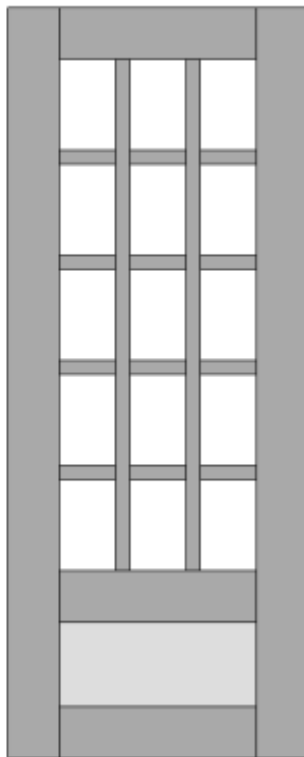
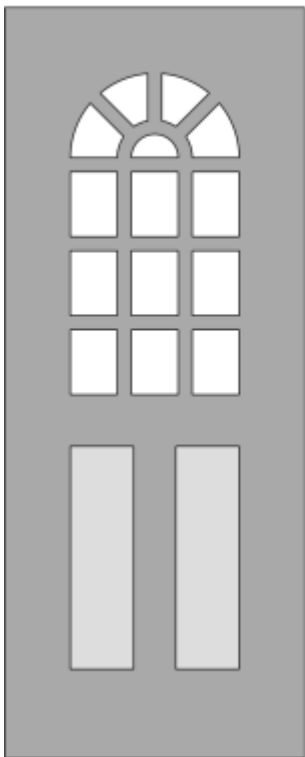
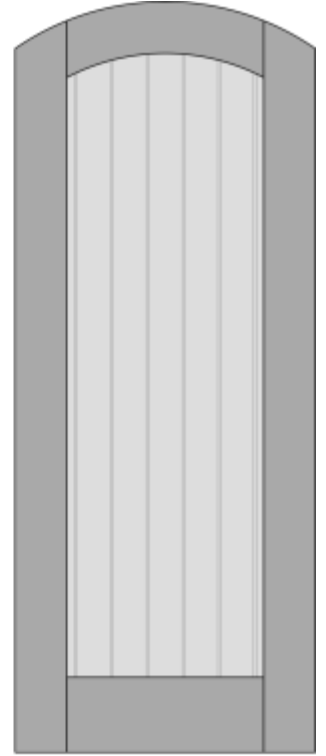
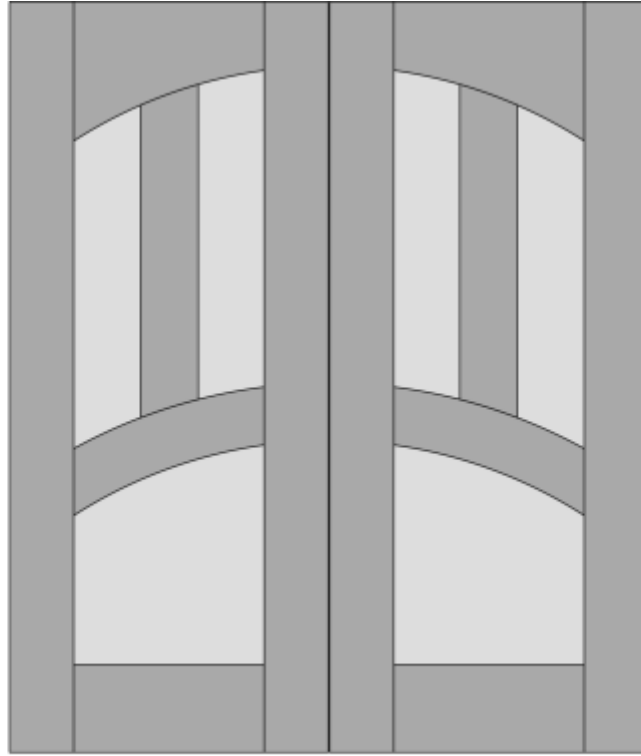
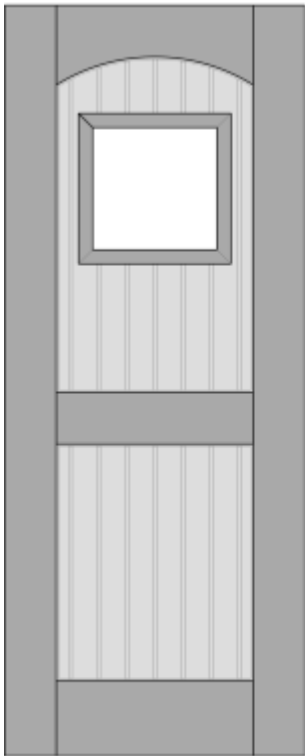

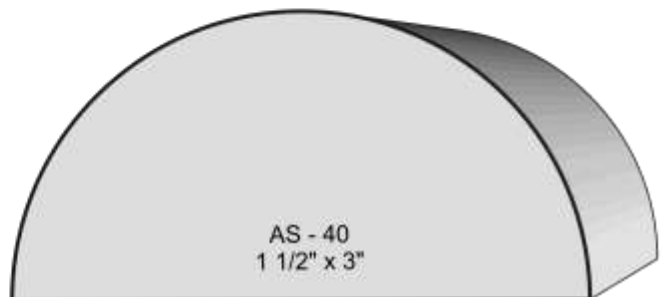
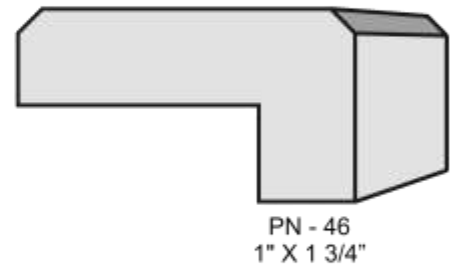
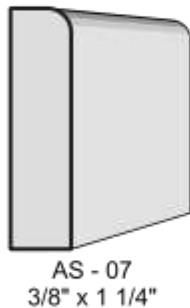
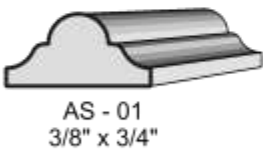
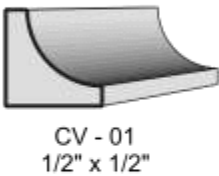
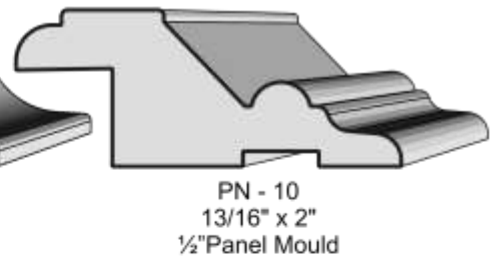
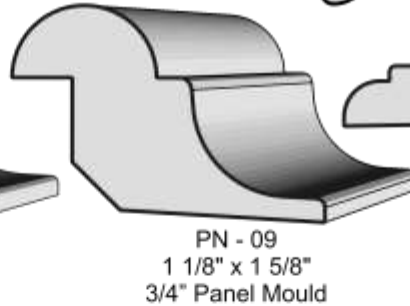
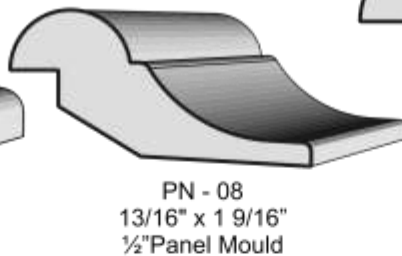
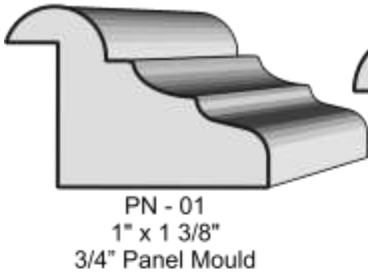
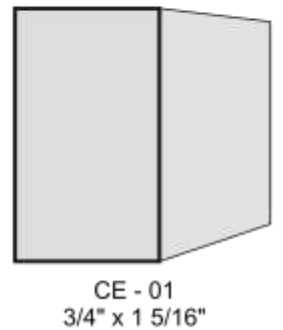
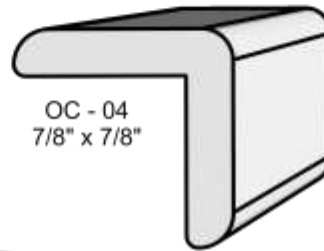
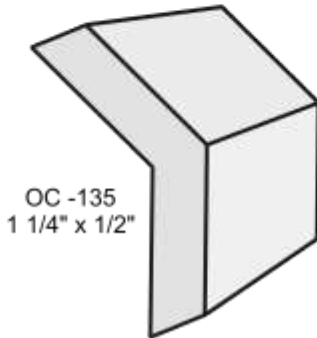
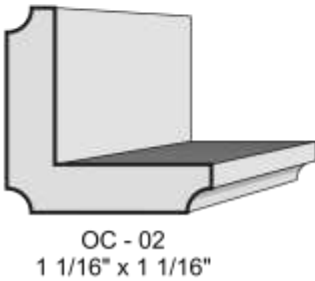
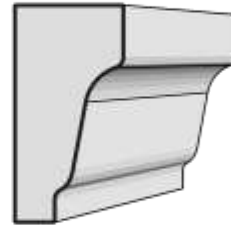
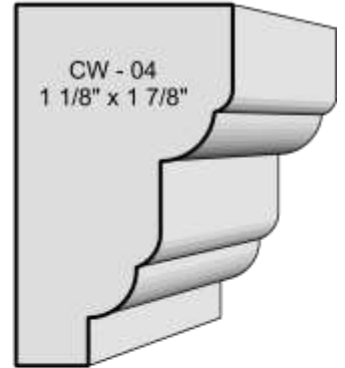
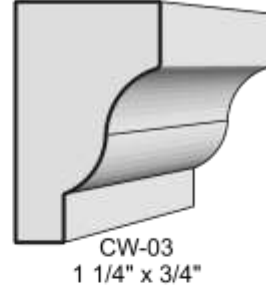
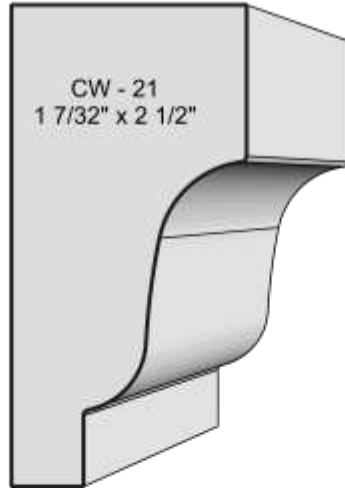
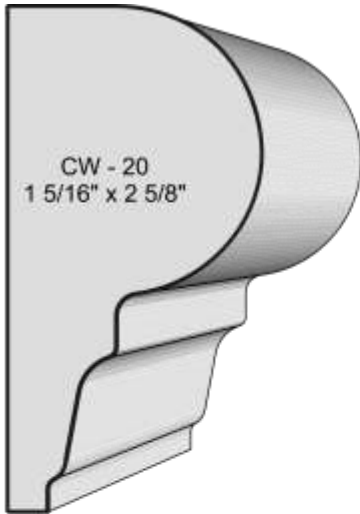

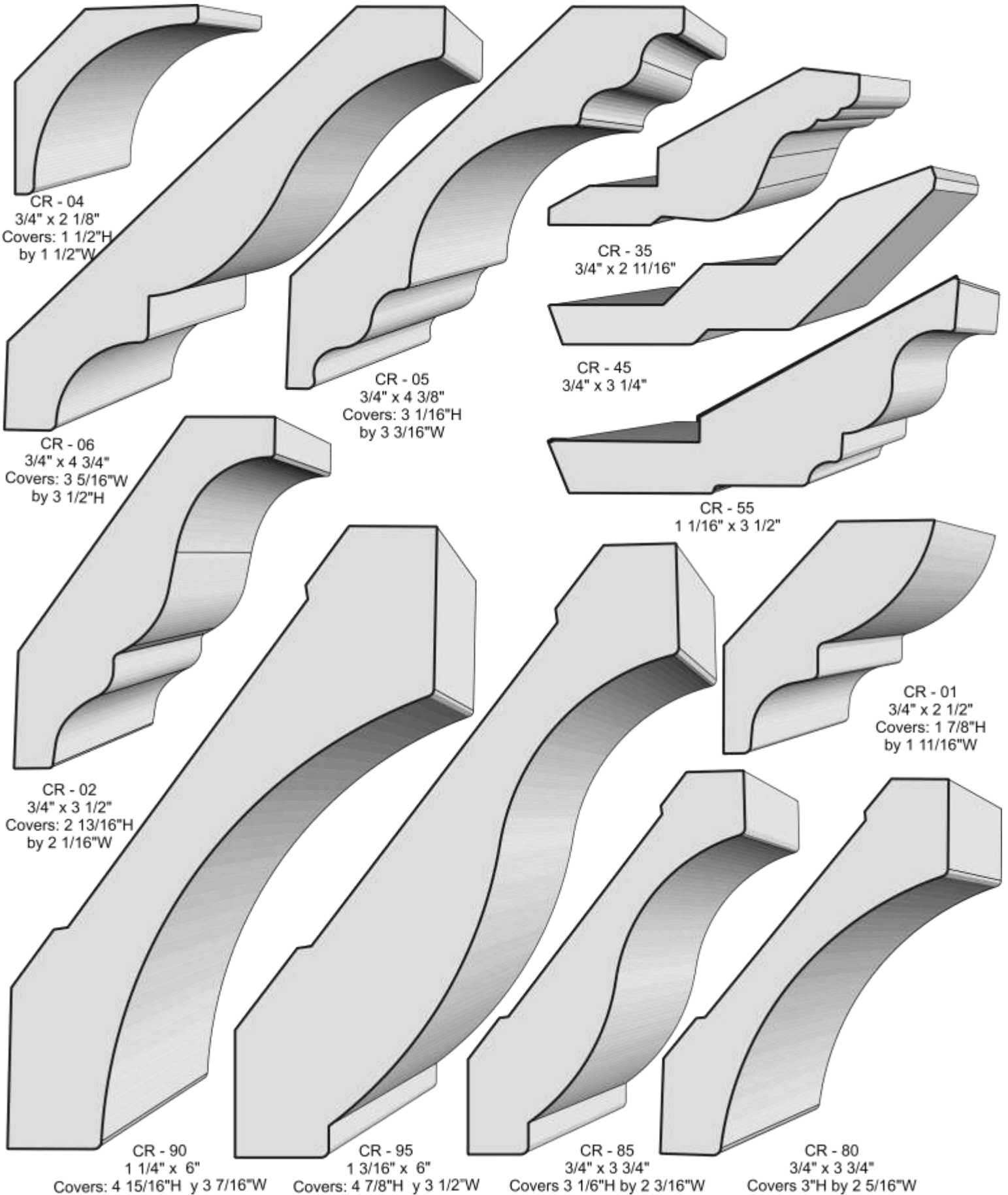

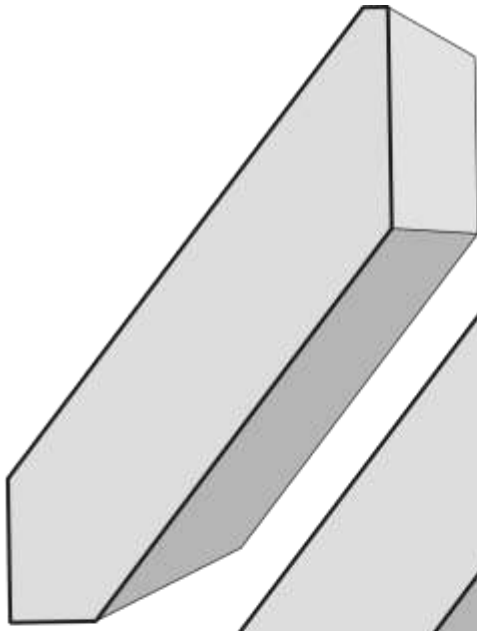

CR - 60
13/16" x 3 3/4"
Covers: 3 3/16"H by 2"W

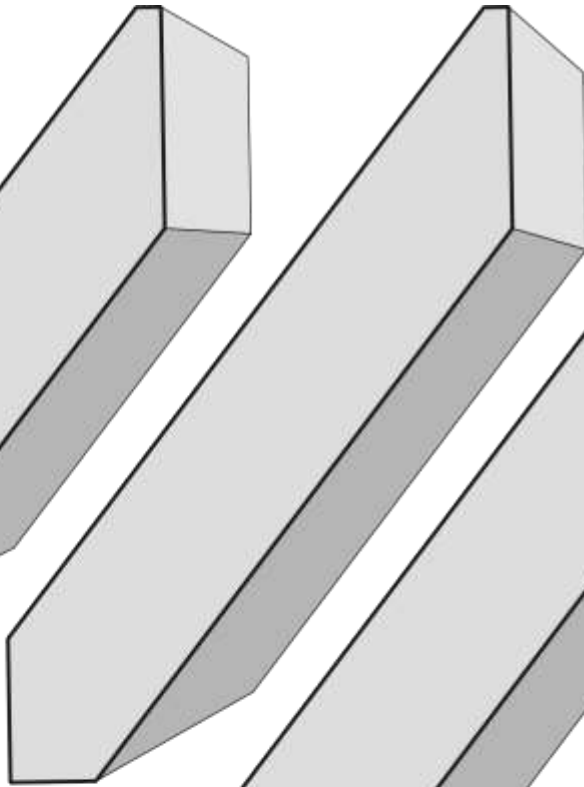

CR - 65
13/16" x 4 13/16"
Covers: 4"H by 2 5/8"W

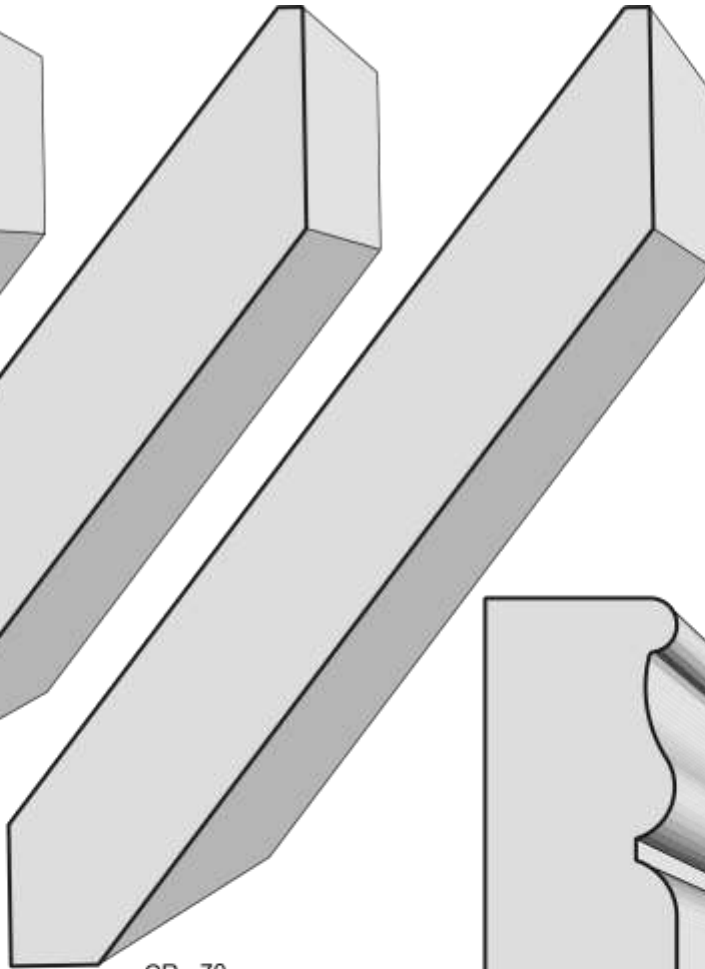

CR - 70
13/16" x 6"
Covers: 5"H by 3 3/8"W

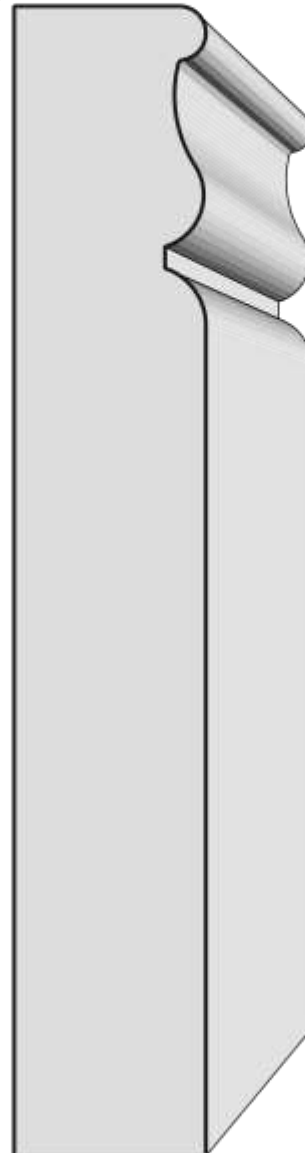

PL - 02
1" x 6"

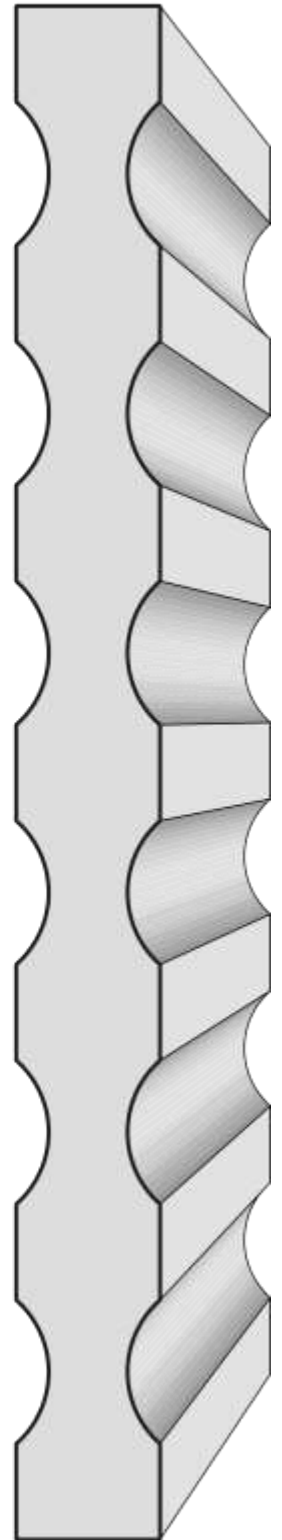

FLU
8" x 3/4" x 8'

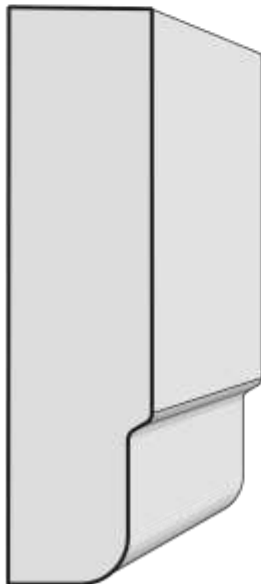

VA - 01
3/4" x 3"

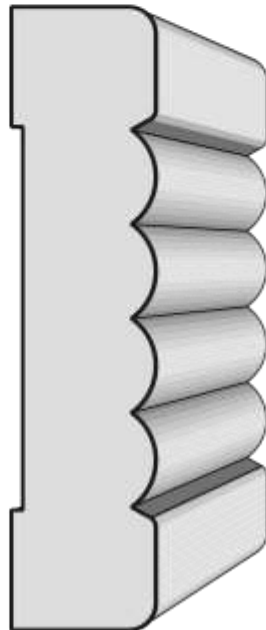

CS - 08
3/4" x 3 1/4"

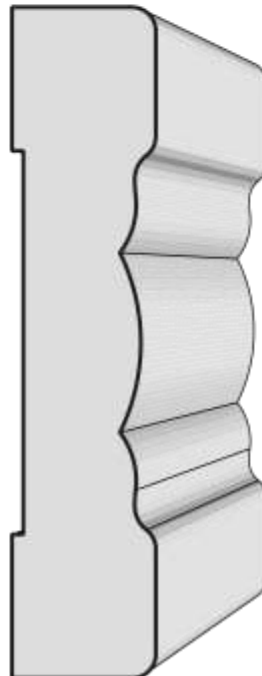

CS - 11
3/4" x 3 1/2"

S4F

Code	Size	Net	Price	Code	Size	Net	Price
1X2ALD	1 x 2	3/4" x 1-1/2"	5.27	1X2MPL	1 x 2	3/4" x 1-1/2"	5.27
1X3ALD	1 x 3	3/4" x 2-1/2"	7.17	1X3MPL	1 x 3	3/4" x 2-1/2"	7.17
1X4ALD	1 x 4	3/4" x 3-1/2"	9.08	1X4MPL	1 x 4	3/4" x 3-1/2"	9.08
1X6ALD	1 x 6	3/4" x 5-1/2"	12.88	* 1X6MPL	1 x 6	3/4" x 5-1/2"	12.88
1X8ALD	1 x 8	3/4" x 7-1/4"	16.23	* 1X8MPL	1 x 8	3/4" x 7-1/4"	16.23
1X10ALD	1 x 10	3/4" x 9-1/4"	20.04	1X10MPL	1 x 10	3/4" x 9-1/4"	20.04

Price per linear foot / random lengths

* Stocking items. Other styles / species available. Call for info.

S3R

Code	Description	Size	Price / BFT
S3RALD	Clear Alder	3/4" x RW	15.68
S3RCHY	Cherry	3/4" x RW	24.84
* S3RMPL	Maple	3/4" x RW	16.03
S3ROAK	Oak	3/4" x RW	30.77
* S3RPOP	Poplar	3/4" x RW	31.09
S3RWAL	Walnut	3/4" x RW	0

Random width and length, planed and sanded two faces, straight line ripped one edge. Pricing per board foot.

Other widths / species available. Call for Info.

* Stocking Items

Wood Moulding

Moulding	Poplar	Maple
AS-01	3.53	4.11
AS-07	4.26	* 5.21
AS-08	3.53	* 4.11
AS-14	4.61	5.76
AS-16	4.98	6.32
AS-17	3.53	4.11
AS-40	11.10	16.54
AS-75	4.26	5.21
AS-975	4.26	5.21
CE-01	4.37	5.34
CR-01	6.06	7.97
CR-02	7.43	10.08
CR-04	5.47	7.06
CR-05	8.76	12.10
CR-06	* 9.47	13.15
CR-35	6.33	8.39
CR-45	7.14	9.63
CR-55	9.30	12.29
CR-60	* 7.87	* 10.74
CR-65	9.38	13.03
CR-70	11.13	15.70
CR-80	* 7.87	* 10.74
CR-85	* 7.87	* 10.74

Moulding	Poplar	Maple
CR-90	* 18.17	* 25.05
CR-95	* 18.17	* 25.05
CS-08	7.14	9.63
CS-11	7.52	10.19
CV-01	* 3.18	3.56
CW-03	4.26	5.21
CW-04	7.37	9.50
CW-20	9.33	12.33
CW-21	9.00	11.85
OC-02	4.54	5.44
OC-04	4.07	* 4.93
OC-135	4.26	5.21
PL-02	14.20	19.31
PN-01	5.14	6.32
PN-06	3.89	4.67
PN-08	4.71	5.90
PN-09	4.81	6.04
PN-10	5.34	6.87
PN-16	4.42	5.26
PN-46	5.88	7.37
VA-01	6.80	9.09
FLU	0.00	175.30

* Stocking items. Other styles / species available. Call for

Code	Description	Price	Lift Price
CA1	1/4 Alder Clear MDF A-4 G1S	205.18	194.92
CAP	3/4 Alder Clear P/C A-1 G2S	232.05	220.45
KA1	1/4 Knotty Alder MDF C-4 G1S	173.19	164.52
KAP	3/4 Knotty Alder P/C C-1 G2S	166.98	158.63
BIRCH12	1/2 Domestic Birch CW-2 V/C	52.49	49.86
CH1	1/4 Cherry MDF A-4 G1S	172.34	163.74
CHP	3/4 Cherry P/C A-1 G2S	191.56	181.98
VGFIR	3/4 Rift Cut Fir G2S(A-1) PC	271.30	n/a
MA1	1/4 Maple MDF B-4 G1S	92.99	88.35
MAC121	1/2 Maple P/C CAB Grade G1S BWPF-4	95.60	95.60
MAC58	5/8 Maple P/C CAB Grade G2S BWPF-1	128.94	121.08
MAC	3/4 Maple P/C CAB Grade G2S BWPF-1	132.63	125.99
MAMD1BP	3/4 Maple MDF Core Bead Board 3cc 8'	185.33	176.07
OAP	3/4 Oak P/C A-2 G2S	#N/A	#N/A
RWOAP	3/4 Rift White Oak G2S(A-1) P/C	204.75	n/a
WA1	1/4 Walnut MDF A-4 G1S	219.69	208.70
WAP	3/4 Walnut P/C A-1 G2S	216.65	205.81
QWOAP	3/4 QTR Sawn White Oak P/C	196.22	186.44
ME2W	1/2 Classic White Melamine 2 Sides	61.92	58.82
ME5W	5/8 Classic White Melamine 2 Sides	53.75	51.06
ME3W	3/4 Classic White Melamine 2 Sides	72.52	68.89
EWAL	3/4 Echo Qtr WALNUT P/C G2S	273.53	n/a
ERWO	3/4 Echo Rift WHITE OAK P/C G2S	273.53	259.88
BB12	12mm Baltic Birch - 60 x 60	145.04	137.79
BB15	15mm Baltic Birch - 60 x 60	127.97	121.58
BB18	18mm Baltic Birch 60 x60	168.92	162.36
SPR34	3/4 Spruce Sheathing	85.31	n/a
K3	5/8 K-3 - Raw Particle Board	37.98	36.03
MD1	1/4 MDF Eco Gold NAF	30.82	29.27
MD3	3/8" MDF Eco Gold NAF	52.31	49.70
MD2	1/2" MDF Premium Ranger	62.35	59.26

Code	Description	Price	Lift Price
MD5	5/8 MDF Premium Ranger	73.17	69.51
MD7P	3/4 MDF Premium Ranger	84.49	80.27
MD7BP	3/4 MDF Bead Board 3cc 8' Shop	105.62	100.34
MED	3/4 Medex Premium	113.95	n/a
ME2CM	1/2 Classic Maple Melamine 2 Sides	69.23	65.76
ME5CM	5/8 Classic Maple Melamine 2 Sides	69.66	66.17
ME3CM	3/4 Classic Maple Melamine 2 Sides	81.41	77.34
ME3CANNEL	*3/4 X 4 X 8 Canella Rustik Melamine G87	114.66	n/a
ME3CASSIS	*3/4 X 4 X 8 Cassis Melamine K17	134.44	n/a
ME3CHILL	*3/4 X 4 X 8 Chill Melamine	110.59	n/a
ME3DCHOC	*3/4 X 4 X 8 Dark Chocolate Melamine L494	97.46	n/a
ME3DRIFT	*3/4 X 4 X 8 Driftwood Melamine H70	134.44	n/a
ME3FROTH	*3/4 X 4 X 8 Froth of the Sea Melamine L080	88.15	n/a
ME3HAZE	*3/4 X 4 X 8 Haze Melamine	110.59	n/a
ME3MARINE	*3/4 X 4 X 9 Marine Blue	303.19	n/a
ME3MISTRAL	*3/4 X 4 X 8 Mistral Melamine K14	134.44	n/a
ME3MYSTIC	3/4 X 4 X 8 Mystic Blue	217.85	n/a
ME3NORTH	*3/4 X 4 X 8 Latitude North Melamine L530	128.99	n/a
ME3SILVA	*3/4 X 4 X 8 Silva Melamine H54	134.44	n/a
ME3SKYE	*3/4 X 4 X 8 Skye Melamine H50	134.44	n/a
ME3STORM	*3/4 X 4 X 8 Storm Melamine	110.59	n/a
ME3TETE	*3/4 X 4 X 8 Tete-E-Tete Melamine M2001	207.83	n/a
ME3WCHOC	*3/4 X 4 X 8 White Chocolate Melamine L492	97.46	n/a
ME3WINTER	*3/4 X 4 X 8 Winter Fun Melamine M2004	193.49	n/a

* Also Available in 1/4" thickness

NOTE: Veneer sheet goods have particle core.
Echo Wood Sheets and Edge Tapes Stocked in Limited Quantities

Slot Wall, Bead Board & V-Grooving Sheet Goods require minimum 5 days for delivery. Requires MDF core, call for pricing and availability.

Code	Item	Price
PGTALD	Alder Veneer Preglued Edge Tape	98.95
PGTCHY	Cherry Veneer Preglued Edge Tape	95.99
PGTMPL	Maple Veneer Preglued Edge Tape	65.33
PGTOAK	Oak Veneer Preglued Edge Tape	76.86
PGTWAL	Walnut Veneer Preglued Edge Tape	105.69
PGTW	Classic White Preglued Edge Tape	65.64
PGTCM	Classic Maple Preglued Edge Tape	90.07
PGTWO	13/16"x250' White Oak preglued	85.06
ET5BAMBO	Bamboo Shoots - 15/16 X .018 X 600 Pvc E/T	123.23
ET5BLACK	Black Velour - 15/16 X .018 X 600 Pvc E/T	95.76
ET5CASHME	Cashmere Dusk - 15/16 X .018 X 600 Pvc E/T	95.76
ET5COTTON	Cotton Mist - 15/16 X .018 X 600 Pvc E/T	95.76
ET5JERSEY	Jersey Fog - 15/16 X .018 X 600 Pvc E/T	123.23
ET5OXFORD	Oxford Grey - 15/16 X .018 X 600 Pvc E/T	123.23
ET5SUEDE	Suede Stone - 15/16 X .018 X 600 Pvc E/T	95.76
ET1BLACK	Black Velour 15/16 X 1mm X 600' PVC E/T	113.18
ET1CARNES	Carnes 15/16 X 1mm X 300' PVC E/T	113.18
ET1CASHME	Cashmere Dusk 15/16 X 1mm X 300' PVC E/T	113.18
ET1CASSIS	Cassis K17 15/16 X 1mm X 300' PVC E/T	113.18
ET1CHILL	Chill 15/16 X 1mm X 300' PVC E/T	113.18
ET1COTTON	Cotton Mist 7/8 X 1mm X 300' PVC E/T	113.18
ET1DRIFT	Driftwood H70 15/16 X 1mm X 500 PVC E/T	113.18
ET1ESTREL	EstereI 15/16 X 1mm X 300' PVC E/T	113.18
ET1FROTH	Froth of the Sea L080 15/16 X 1mm X 600 PVC E/T	129.77
ET1HAZE	Haze3 15/16 X 1mm X 300' PVC E/T	113.18
ET1MARINE	Marine Blue - 1mm X 15/16 X 300 Pvc E/T	124.90
ET1MISTRAL	Mistral K14 15/16 X 1mm X 300' PVC E/T	113.18
ET1MONACO	Monaco K18 15/16 X 1mm X 300' PVC E/T	113.18
ET1NIZZA	Nizza 15/16 X 1mm X 300' PVC E/T	113.18
ET1NORTH	Latitude North L530 15/16 X 1mm X 300 PVC E/T	129.77
ET1SILVA	Silva H54 15/16 X 1mm X 300' PVC E/T	113.18
ET1SKYE	Skye H50 15/16 X 1mm X 300' PVC E/T	113.18
ET1STORM	Storm 15/16 X 1mm X 500' PVC E/T	113.18
ET1SUEDE	Suede Stone 7/8 X 1mm X 300' PVC E/T	113.18
ET1TETE	Tete-E-Tete 15/16 X 1mm X 300' PVC E/T	154.49
ET1WCHOC	White Chocolate L492 15/16 X 1mm X 300 PVC E/T	129.77
ET1WINTER	Winter Fun 15/16 X 1mm X 300' PVC E/T	154.49

Melamine Cabinet Components - White Melamine, Maple Melamine
 **White Melamine With Oak or Maple Veneer Edge (Not Stock Item allow 2 weeks)

Code	Item	Size (Imperial)		Size (Metric)		White	Maple	White Melamine Veneer Edge**
		H	W	H	W			
SG	Stove Gable	15 1/8	x 12 1/8	384	x 308	12.09	15.19	13.57
SG1	Stove Gable One	20 1/8	x 12 1/8	512	x 308	15.96	20.15	17.14
SGS	Stove Gable Special	26 1/2	x 12 1/8	672	x 308	19.84	28.68	22.09
UG	Upper Gable	31 1/2	x 12 1/8	800	x 308	16.82	24.18	18.21
UG1	Upper Gable One	36 1/2	x 12 1/8	928	x 308	19.84	24.95	22.09
UGS	Upper Gable Special	42 7/8	x 12 1/8	1088	x 308	23.80	29.06	25.51
DUG	Douglas Upper Gable	36 1/2	x 15 7/8	928	x 404	21.31	25.66	22.86
DGS	Douglas Gable Special	42 7/8	x 15 7/8	1088	x 404	25.05	29.69	26.82
MG	Microwave Gable	15 1/8	x 15 7/8	384	x 404	15.96	20.15	17.14
MG1	Microwave Gable One	20 1/8	x 15 7/8	512	x 404	16.98	21.31	18.21
MGS	Microwave Gable Special	26 1/2	x 15 7/8	672	x 404	18.85	23.64	20.85
VG	Vanity Gable	27 3/4	x 20 3/8	704	x 518	21.40	25.73	23.80
VGS	Vanity Gable Special	26 7/16	x 20 3/8	672	x 518	21.40	25.73	23.80
FG	Fridge Gable	15 1/8	x 23 1/2	384	x 596	16.82	22.01	18.61
FG1	Fridge Gable One	20 1/8	x 23 1/2	512	x 596	19.06	22.86	20.40
FGS	Fridge Gable Special	26 1/2	x 23 1/2	672	x 596	21.31	25.66	23.72
LG	Lower Gable	31 1/2	x 23 1/2	800	x 596	21.95	26.35	24.34
LGS	Lower Gable Special	30 1/4	x 23 1/2	768	x 596	21.95	26.35	24.34
PG	Pantry Gable	80 5/8	x 23 1/2	2048	x 596	52.70	66.27	58.60
PGS	Pantry Gable Special	92	x 23 1/2	2336	x 596	55.27	69.44	61.46
DUTB	Drilled Upper Top/Bottom	96	x 12 1/8	2440	x 308	50.84	60.45	56.51
DMWB	Drilled Microwave Bottom	96	x 15 7/8	2440	x 404	54.72	65.65	60.76
CN1	Corner Gable One	30 1/4	x 6	768	x 152	16.82	20.24	n/a
CN2	Corner Gable Two	35 1/4	x 6	896	x 152	18.69	22.56	n/a
CN3	Corner Gable Three	41 1/2	x 6	1056	x 152	19.84	23.86	n/a
CUS	22" Corner Upper Shelf (308 gable)	21 5/8	x 21 5/8	551	x 551	18.75	22.63	21.01
CS1	26" Corner Upper Shelf (308 gable)	25 3/4	x 25 3/4	651	x 651	21.70	26.19	24.03
DCS	26" Corner Upper Shelf (404 gable)	25 3/4	x 25 3/4	651	x 651	26.29	33.01	28.61
CUB	22" Corner Upper Bottom (308 gable)	22	x 22	559	x 559	18.75	22.63	21.01
CB1	26" Corner Upper Bottom (308 gable)	26	x 26	660	x 660	22.40	26.96	24.03
DCB	26" Corner Upper Bottom (404 gable)	26	x 26	660	x 660	26.29	33.01	28.61
CLB	Corner Lower Bottom (596 gable)	31 1/2	x 31 1/2	800	x 800	25.35	30.54	27.60
CL90	L Shaped Lower Bottom (596 gable)	36	x 36	914	x 914	27.99	33.64	30.23
DSR	*Drawer Rail – Small (5/8" Rabbet)	97	x 4	2464	x 100	14.19	17.75	16.36
DMR	*Drawer Rail – Medium (5/8" Rabbet)	97	x 5	2464	x 127	16.06	20.30	18.29
DLR	*Drawer Rail – Large (5/8" Rabbet)	97	x 6 3/4	2464	x 170	18.07	22.86	20.24
DXR	*Drawer Rail – Extra Large (5/8" Rabbet)	97	x 9	2464	x 230	24.57	31.40	26.82
D4D	Drawer Rail – Small (5/8" Dado)	97	x 4	2464	x 100	25.47	30.26	23.72
D5D	Drawer Rail – Medium (5/8" Dado)	97	x 5	2464	x 127	27.68	33.32	25.51
D7D	Drawer Rail – Large (5/8" Dado)	97	x 6 3/4	2464	x 170	30.00	36.27	27.51
D9D	Drawer Rail – Extra Large (5/8" Dado)	97	x 9	2464	x 230	37.83	46.49	34.04
D12D	Drawer Rail – File (5/8" Dado)	97	x 12	2464	x 308	40.78	53.80	36.59
MDS	Drawer Rail – Small	97	x 4	2464	x 100	11.71	15.19	12.86
MDL	Drawer Rail – Large	97	x 6 3/4	2464	x 170	15.43	20.24	17.30
MDX	Drawer Rail – Extra Large	97	x 9	2464	x 230	22.01	28.84	23.56
US	Upper Shelf	97	x 11 3/8	2464	x 288	22.56	30.77	24.80
UTB	Upper Top/Bottom	97	x 12 1/8	2464	x 308	22.56	30.77	24.95
MWB	Microwave Bottom	97	x 15 7/8	2464	x 404	26.44	35.95	29.29
VB	Vanity Bottom	97	x 20 3/8	2464	x 518	38.21	50.00	42.16
LS	Lower Shelf	97	x 22 5/8	2464	x 576	38.21	52.01	42.47
LB	Lower Bottom	97	x 23 1/2	2464	x 596	38.44	54.34	42.71
SB	Sink Bottom	97	x 25 1/2	2464	x 648	41.61	56.58	44.02

* Special Order

Style	Item	Unit	Price	Pair/Case	Case Price
F6	6" Full Extension Slides - Accuride	pair	21.52	10	193.69
F8	8" Full Extension Slides - Accuride	pair	21.72	10	195.42
F10	10" Full Extension Slides - Accuride	pair	24.31	10	218.82
F12	12" Full Extension Slides - Accuride	pair	24.31	10	218.82
F14	14" Full Extension Slides - Accuride	pair	24.99	10	224.82
F16	16" Full Extension Slides - Accuride	pair	25.66	10	230.92
F18	18" Full Extension Slides - Accuride	pair	26.43	10	237.84
F20	20" Full Extension Slides - Accuride	pair	27.58	10	248.22
F22	22" Full Extension Slides - Accuride	pair	29.50	10	265.51
HQ10	Hettich Quadro 4D - 10 Undermount w/clips	pair	34.87		n/a
HQ12	Hettich Quadro 4D - 12 Undermount w/clips	pair	34.87		n/a
HQ14	Hettich Quadro 4D - 14 Undermount w/clips	pair	34.87		n/a
HQ16	Hettich Quadro 4D - 16 Undermount w/clips	pair	34.87		n/a
HQ18	Hettich Quadro 4D - 18 Undermount w/clips	pair	37.04		n/a
HQ20	Hettich Quadro 4D - 20 Undermount w/clips	pair	39.15		n/a
HQ22	Hettich Quadro 4D - 22 Undermount w/clips	pair	41.26		n/a
HSLIMIT	Hettich hinge opening angle limiter to 85 degrees	each	0.46		n/a

Style	Item	Unit	Price	Pair/Case	Case Price
HS10	110° Inset Fix Soft Close - Hettich Sensys	pair	19.89	125	n/a
HS11	110° Full Overlay Fix Soft Close - Hettich Sensys	pair	13.20	125	n/a
HS12	110° Half Overlay Fix Soft Close - Hettich Sensys	pair	17.59	125	n/a
HS95	95° Full Overlay Soft Close - Hettich Sensys	pair	17.28	125	n/a
HS17	165° Fix Self Close - Hettich Sensys	pair	19.04	125	n/a
HS45	45° Fix Self Close - Hettich Sensys	pair	23.68	125	n/a
HSF1	110° Face Frame Fix Soft Close - Hettich Sensys	pair	3.14	100	n/a
HSLS	Fix Bi-Fold - Hettich Sensys	pair	18.15	100	n/a

Style	Item	Unit	Price
WA740A	Wilsonart Contact Cement 14.2 oz	ea	26.79
WAMELS	Wilsonart Melamine Glue 473ML	ea	19.70
WA10S	Wilsonart WA10 Glue 473ML	ea	9.99
WA10M	Wilsonart WA10 Glue 3.78L	ea	43.43
WA10L	Wilsonart WA10 Glue 18.9L	ea	160.14
CAPW	FastCap White Sticky Screw Cap - Sheet of 52	ea	5.26
CAPWC	FastCap White Sticky Screw Cap - Pkg of 1040	pkg	94.54
CAPM	FastCap Maple Sticky Screw Cap - Sheet of 52	ea	6.60
CAPMC	FastCap Maple Sticky Screw Cap - Pkg of 1040	pkg	118.75
SHF	Shelf clips - 100 pkg, clear w/metal pin	pkg	9.87
BMP	Rubber Door Bumpers - Sheet of 200, Clear	ea	26.84
SCSP	13mm Euro Screw Pkg of 50 - #2 Phillips Head	pkg	6.15
SCWC	#6-5/8" Screw Pack of 100 - #1 Robertson	pkg	5.44
SPR	1" Slide Spacer Set - Set of 4 w/ Screws	set	5.44

Style	Item	Unit	Price
OIL	500ml denatured mineral oil - butcher	ea	9.16
CSB411	10x80T High ATB (for Melamine)	ea	198.10
CSB431	10x50T 4 & 1 Miter Saw (for all species)	ea	218.54
CSB445	10x80T Triple Chip N/F(table/chop saw)	ea	196.19
DB5	5mm Brad Point Drill - Shelf Clip Holes	ea	30.11
CC40	40" x 250' corrugated cardboard - 1 Side	ea	124.21
CC30	30" x 250' corrugated cardboard - 1 Side	ea	91.78
WRAP	Bubble Wrap 48" x 250" Roll	ea	186.32
FOAM	3/32 X 48 X 750' PERF AT 1/2"	roll	366.50
CLOSETRO	Closet Rod 1-5/16" round chrome 12'	ea	67.05
CLOSETFLG	Closet Rod Holder/Flange Chrome	Set	8.93
WGLUB	500ML Empty Glue Bottle	ea	3.33

PRODUCT WARRANTY

Products manufactured by Multiwood Inc. (hereinafter referred to as Multiwood) are warranted by Multiwood to be free from failure resulting from defects in material and/or workmanship, within the following limitations:

1. Multiwood agrees to repair or replace, at its option, any part of its own manufacture which proves to be defective, within six months, provided the products have not been subjected to unreasonable abuse or damage and have received reasonable care, commencing from the date of manufacture, provided such parts are returned prepaid to our factory and upon return, found to be defective in material or workmanship. Items that are not returned to our factory (prepaid) for our direct inspection/evaluation will not be warranted.
2. Multiwood will only repair or replace defective product in its original, unfinished state. Once it has been altered (including, but not limited to, chemically treated, painted, stained or lacquered) the warranty will become null and void (excepting structural failure).
3. Natural characteristics of the wood (including but not limited to knots, discoloration, mineral streaking, burl and grain pattern) will not be considered a defect unless specified on the original order. REFER to Wood Specifications
4. Subjecting products to excessive heat, cold or humidity, improper or incorrect installation of hardware or the improper application of finish is sufficient grounds for disqualification under this warranty.
5. Any component or part, whether manufactured by Multiwood or any others, which show signs of abuse, neglect, accident, improper handling, unauthorized alteration or use in such manner as was not intended shall be excluded from any warranties, expressed or implied.
6. Any part that Multiwood considers to be a maintenance item shall be excluded from any warranties, expressed or implied.
7. All defective parts must be returned to our factory with all transportation, customs and duty charges prepaid.
8. Any warranted replacement parts/products from Multiwood or other manufactures are shipped FOB (collect) from each respective factory.
9. All warranty work to be performed by others must be pre-approved in writing by Multiwood.
10. Multiwood shall not be held liable for any extraneous charges, damages, delays or lost production caused by such defects in material and/or workmanship as described above. The liability of Multiwood under this warranty is limited to the repair and/or replacement (at our option) as originally supplied, as set forth above, providing the claim is made within the above noted warranty period.
11. Any requests to alter our normal construction specifications are not guaranteed.
12. **Multiwood will only accept warranty claims on warped wood doors if the warp is more than 1/16 per 18" of height for doors under 24" wide, and 3/32 per 18" of height for doors over 24" wide, (1mm per 300mm of height for doors under 610mm wide, and 1.5mm per 300mm for doors wider than 610mm.). In ALL cases the maximum warranty heights are 42" (1067mm) or 50" (1270mm) with a cross rail and 28" for width.**
13. There are no other warranties of any kind, expressed or implied.

Pertinent to Wood Mitered Doors:

It is an inherent fact that wood will expand and contract with changes in weather and humidity. Almost all of this movement will occur across the grain. The width of the piece of wood will increase with an increase in humidity or decrease with a decrease in humidity. Mitered doors will react the same way. As the wood in a mitered door takes on moisture the joint will tend to open up on the outside edge of the door. A gap of .5mm is normal during high humidity conditions. If a mitered door loses moisture it will tend to open on the inside of the miter. Under normal humidity conditions mitered doors may open up .5mm. This will not be considered a warranty condition. This movement of wood is beyond our control and is an expected change.

This warranty is expressly in lieu of and supersedes all other warranties, expressed or implied, written or oral, including without limitation any warranties of merchantability or suitable for a particular purpose or application.

Warranty Administration - Please provide invoice for warranties

All warranty claims must be made, in writing, to: Multiwood Inc. 11580 40th Street South East Calgary, Alberta T2C 1N9 within 10 days of the manifestation of the defect. Multiwood's obligation on warranty claims and Buyer's Remedy therefore shall be exclusively limited to, at Multiwood's option, any one of the following:

1. Replacing at Multiwood's factory any part proved to be defective,
2. Remediating or repairing such defect, or
3. Refunding the original purchase price in the form of a credit to be applied to future purchases.

Multiwood may require the return of (or upon Multiwood's prior written consent, Buyer may return) the alleged defective part, transportation charges to be paid by Buyer, before Multiwood recognizes any claim for defective workmanship or material. If the claim is not recognized, Buyer shall reimburse Multiwood for Multiwood's expenses in investigating the claim. Buyer shall pay travel and living expenses for any warranty work Multiwood determines must be undertaken at Buyer's site.

Limitation of Liability

Multiwood's liability under this warranty will be limited to replacing or repairing the defective product at our option. In no case will Multiwood's liability exceed the contractual value of the order. Buyer's exclusive remedy for any loss or claim resulting from the use or inability to use this product shall be repair or replacement of the defective product, or, at the option of Multiwood, return of the product to Multiwood and refund of the original purchase price.

Finishing Maple

Wiping stain is not recommended on Maple. Multiwood will not be responsible for any colour or wood variations/defects on maple products when wiping stain has been used.

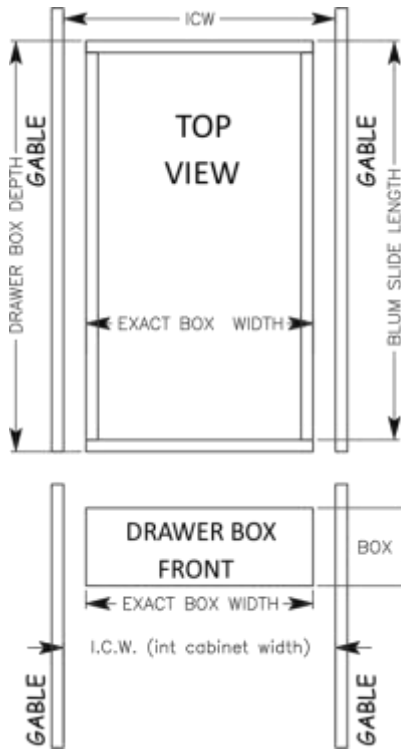

MultiWood Dovetail Drawer Box

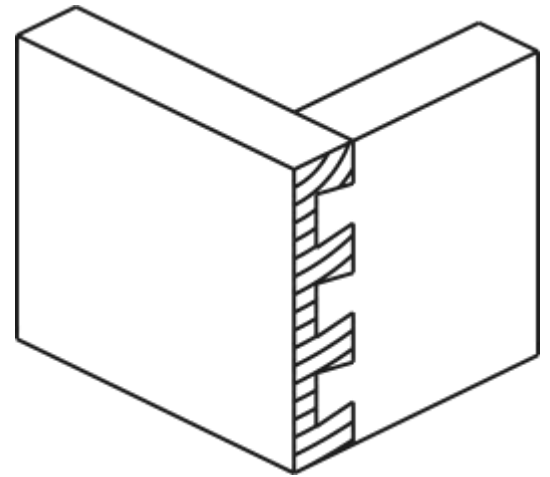
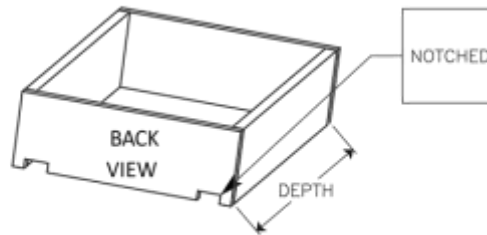

How to Order / Confirm Order

1. What drawer slides are you using?
(do you require BLUM clips?)
2. What is the ICW?
(Internal Cabinet Width)
or EXACT Width?
3. What is Standard Drawer Height?
4. What Species do you want?
 - Solid Birch UV / 9.5mm Melamine Bottom (best value)
 - Solid Birch UV / 9.5mm Plywood Bottom
 - Baltic Birch Plywood / 12mm Bottom
 - Baltic Birch Plywood / 9.5mm Plywood Bottom
 - Baltic Birch Plywood / 9.5mm Melamine Bottom
 - Solid Maple / 9.5mm Plywood Bottom

Scoop Handle Types for Internal Drawers

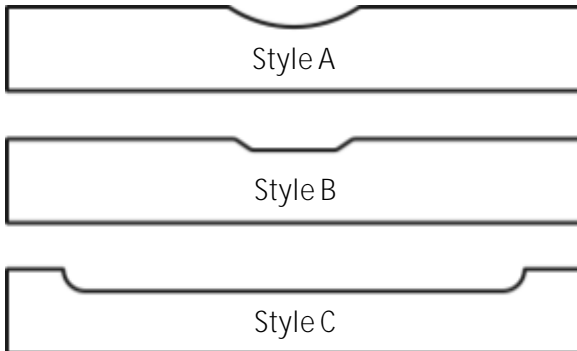

STANDARD DRAWER HEIGHTS

Solid Birch / Maple	
mm	inches
57 mm	2 1/4
83 mm	3 1/4
108 mm	4 1/4
133mm	5 1/4
184 mm	7 1/4
210 mm	8 1/4
235 mm	9 1/4
292mm	11 1/2

Example Pricing

For blumotion slides, w/back notched

ICW	DEPTH	HEIGHT	Solid Birch / 9mm Melamine Bottom
8	x 20	x 4 1/4	47.39
8	x 20	x 6 1/4	57.40
16	x 22	x 2 1/4	45.27
16	x 22	x 4 1/4	59.86
16	x 22	x 5 1/4	65.66
16	x 22	x 7 1/4	80.25
16	x 22	x 8 1/4	86.06
16	x 22	x 9 1/4	93.35
32	x 22	x 4 1/4	81.18
32	x 22	x 7 1/4	109.01
32	x 22	x 9 1/4	127.07

For blumotion slides, w/back notched

ICW	DEPTH	HEIGHT	Solid Maple / 9mm Plywood Bottom
8	x 20	x 4 1/4	62.23
8	x 20	x 6 1/4	79.73
16	x 22	x 2 1/4	59.43
16	x 22	x 4 1/4	84.08
16	x 22	x 5 1/4	95.15
16	x 22	x 7 1/4	119.80
16	x 22	x 8 1/4	130.84
16	x 22	x 9 1/4	143.16
32	x 22	x 4 1/4	121.38
32	x 22	x 7 1/4	171.26
32	x 22	x 9 1/4	204.05

** no clips installed **

THE NEXGEN™ EVOLUTION CONTINUES

Introducing Multiwoods New Pre-Finished NEXGEN™ 5 Piece Cabinet Doors manufactured using a cope & stick construction method. The new NEXGEN™ Door offers you a contemporary shaker look with all the benefits of the original doors using most of the colours and textures offered in the current NEXGEN program. If you require any further information please call us or if you require a quote please email your cabinet door sizes to info@multiwood.com



Better Than Nature

NEXGEN™ 

11580-40 Street SE, Calgary AB
Tel (403) 279-7789 Fax: (403) 279-2819
info@multiwood.com
www.multiwood.com

MultiWood *inc.*

